

Autopar[®]

Drive Train

CRUCETAS

Universal Joints



*Escanea y llévános
en tu smartphone*



Catálogo 2022

kuo
refacciones

Autopar[®]

Drive Train



**Diferentes Aplicaciones
Una sola Calidad**

ÍNDICE

ÍNDICE	1
CRUCETA	2
DETERMINACIÓN DE LA SERIE DEL CARDAN MEDIANTE EL YUGO	3
GUÍA POR APLICACIÓN	4
CRUCETAS SEGUROS EXTERNOS	26
CRUCETAS SEGUROS INTERNOS	30
CRUCETAS SEGUROS MIXTOS	34
CRUCETAS SEGUROS PLACAS	34
CRUCETAS SEGUROS EXTERNOS-PLACAS	38
CRUCETAS SEGUROS EXTERNOS-RIEL	38
CRUCETAS DE RIEL	38
CRUCETAS TIPO SPL	38
ABRAZADERAS	42
CONSECUTIVO CON IMAGEN	44
GUÍA RÁPIDA	54

CRUCETA

La cruceta ó junta universal de cardan, es un elemento de acoplamiento el cual permite unir dos ejes (tubos) en diferentes ángulos de trabajo, permitiendo la transmisión de torque proveniente de la caja de cambios al diferencial trasero y a las ruedas.

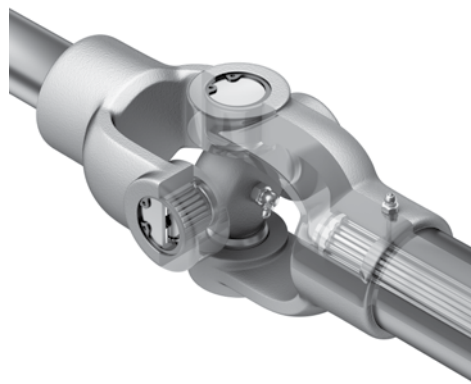

SEGMENTO DE APLICACIÓN POR SERIE

SERIE	SEGMENTO	APLICACIÓN
1280	LIGERO	AUTOMÓVILES CAMIONETAS PICKUP
1310		
1330		



SERIE	SEGMENTO	APLICACIÓN
1350	SEMIPESADO	AUTOBUSES, CAMIONETAS, PICKUP, SEMIPESADAS, CAMIONES LIGEROS, MICROBUSES.
1310		
1480		



SERIE	SEGMENTO	APLICACIÓN
1550	PESADO	CAMIONES, TRACTOCAMIONES AUTOBUSES
1610		
1650		
1710		
1760		
1810		



IDENTIFICACIÓN POR TIPO DE SEGUROS

Las crucetas más comunes que podemos encontrar y que son utilizadas en la mayoría de los vehículos comerciales son 2: Cruceta de seguros Internos, cruceta de seguros externos. Estos tipos de crucetas las podemos identificar mediante el seguro que lleva, como se ve en el diagrama.

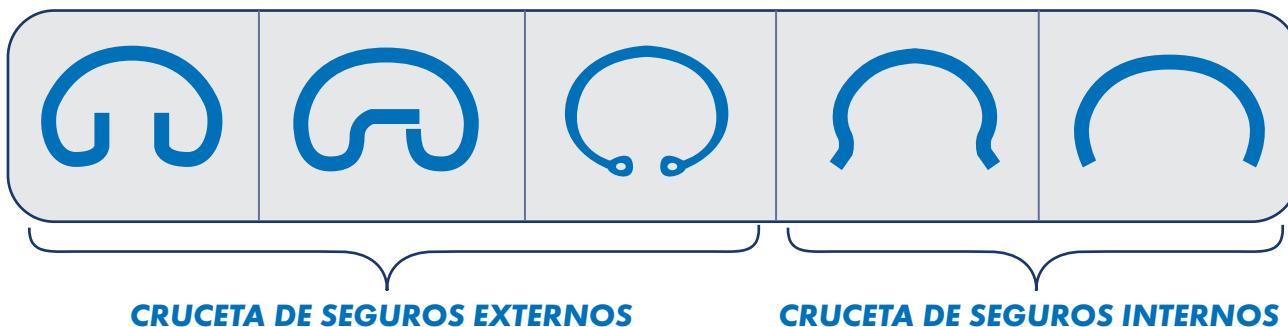

CRUCETA DE SEGUROS EXTERNOS

CRUCETA DE SEGUROS INTERNOS

DETERMINACIÓN DE LA SERIE DEL CARDAN MEDIANTE EL YUGO

Se puede identificar la serie a la que pertenece la cruceta mediante la siguiente medición, para esto es necesario contar con la **regleta por serie Autopar**.

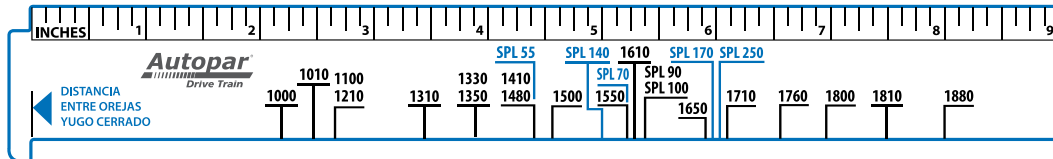

Dependiendo del tipo de yugo procederemos a medir

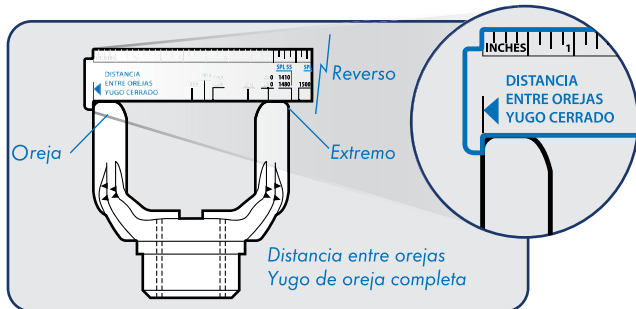
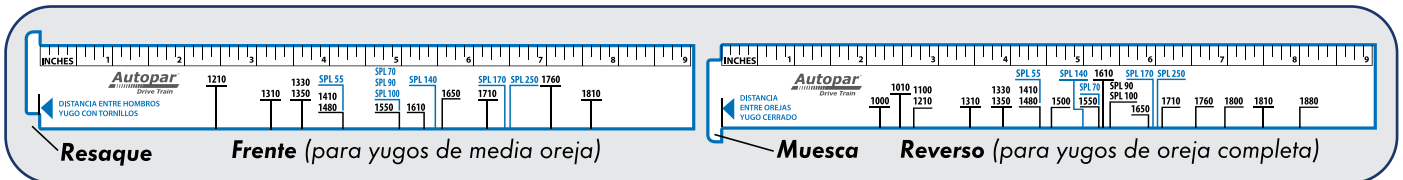

YUGO DE OREJA COMPLETA

Tome la regla Cardán Autopar, utilizando el **reverso** asiente la muesca en una de las orejas del yugo (Fig.2), verifique cuál línea de la regla coincide con el extremo de la oreja posterior (Fig.1) y así obtenemos la serie de la **cruceta** y el yugo Autopar.

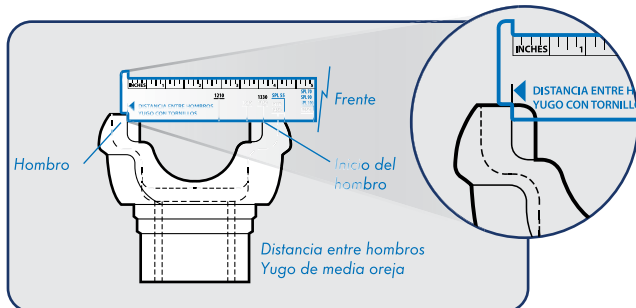

YUGO DE MEDIA OREJA

Tome la regla Cardán Autopar, utilizando el **frente** asiente el resaque en uno de los hombros del yugo (Fig.4), verifique cuál línea de la regla coincide con el inicio del hombro (Fig.3) y así obtenemos la serie de la **cruceta** y el yugo Autopar.



MANTENIMIENTO

Le recordamos realizar intervalos de mantenimiento como se muestra en la siguiente tabla, para un mejor desempeño y duración de nuestros productos.

Importante: Al instalar cada cruceta es necesario llenarla de grasa lubricante, la cantidad de grasa que contiene una cruceta nueva solo es para evitar la oxidación por almacenaje.

TIPO DE SERVICIO	KILÓMETROS	TIEMPO
CIUDAD	8,000/12,000	3 MESES
CARRETERA	16,000/24,000	1 MES

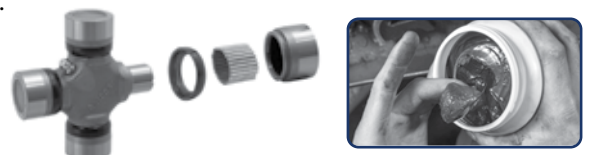

Recomendamos utilizar una grasa de extrema presión a base de jabón de litio grado 1 ó 2.

Autopar[®]

Drive Train

GUÍA POR APLICACIÓN



ARMADORA/MODELO	AÑO INICIAL NOV 2008	AÑO FINAL ENE 2021	NO. DE PARTE Autopar®	TIPO DE CRUCETA 	SERIE
-----------------	----------------------------	--------------------------	---------------------------------	--	-------

AMERICAN MOTORS

AMBASSADOR	1967	1974	A-252X	CRUCETA SEGURO EXTERNO	1310
AMERICAN	1973	1978	A-153X	CRUCETA SEGURO EXTERNO	1310
AMERICAN	1968	1968	A-252X	CRUCETA SEGURO EXTERNO	1310
AMX	1978	1980	A-153X	CRUCETA SEGURO EXTERNO	1310
AMX	1978	1980	A-200X	CRUCETA SEGURO EXTERNO	1280
AMX	1978	1980	A-252X	CRUCETA SEGURO EXTERNO	1310
CONCORD	1978	1983	A-252X	CRUCETA SEGURO EXTERNO	1310
CONCORD	1978	1981	A-1306X	CRUCETA SEGURO INTERNO	7260
EAGLE	1980	1988	A-153X	CRUCETA SEGURO EXTERNO	1310
EAGLE	1980	1988	A-252X	CRUCETA SEGURO EXTERNO	1310
EAGLE	1980	1988	A-252X	CRUCETA SEGURO EXTERNO	1310
GREMLIN	1970	1974	A-153X	CRUCETA SEGURO EXTERNO	1310
GREMLIN	1970	1974	A-252X	CRUCETA SEGURO EXTERNO	1310
GREMLIN	1975	1975	A-437G-1741X	CRUCETA SEGURO EXTERNO	1210
GREMLIN	1975	1976	A-1306X	CRUCETA SEGURO INTERNO	7260
HORNET	1970	1974	A-252X	CRUCETA SEGURO EXTERNO	1310
JAVELIN	1968	1974	A-252X	CRUCETA SEGURO EXTERNO	1310
MATADOR	1971	1978	A-252X	CRUCETA SEGURO EXTERNO	1310
MATADOR	1975	1975	A-437G-1741X	CRUCETA SEGURO EXTERNO	1210
MATADOR	1975	1978	A-1306X	CRUCETA SEGURO INTERNO	7260
PACER	1975	1980	A-252X	CRUCETA SEGURO EXTERNO	1310
PACER	1975	1975	A-437G-1741X	CRUCETA SEGURO EXTERNO	1210
RAMBLER	1969	1969	A-252X	CRUCETA SEGURO EXTERNO	1310
SPIRIT	1979	1981	A-1306X	CRUCETA SEGURO INTERNO	7260

BUICK

ELECTRA	1982	1984	A-178X	SEGURO EXTERNO	1350
ELECTRA	1961	1962	A-213X	SEGURO EXTERNO	1330
LESABRE	1961	1962	A-213X	SEGURO EXTERNO	1330
RAINIER	2004	2007	A-445-1006X	SEGURO INTERNO	1310

CADILLAC

DEVILLE	1982	1984	A-178X	SEGURO EXTERNO	1350
DEVILLE	1957	1962	A-213X	SEGURO EXTERNO	1330
DEVILLE	1957	1962	A-621X	SEGURO INTERNO / EXTERNO	1330 - S44
ESCALADE	2015	2016	A-160X	SEGURO EXTERNO	1410
ESCALADE	2007	2014	A-178X	SEGURO EXTERNO	1350
ESCALADE	1999	2016	A-534G-1014X	SEGURO INTERNO	1344
ESCALADE	2015	2016	A-160X	SEGURO EXTERNO	1410
ESCALADE	2003	2014	A-534G-1014X	SEGURO INTERNO	1344
ESCALADE	2009	2013	A-178X	SEGURO EXTERNO	1350
ESCALADE	2002	2013	A-534G-1014X	SEGURO INTERNO	1344
FLEETWOOD	1957	1962	A-213X	SEGURO EXTERNO	1330
SERIES 62	1960	1995	A-213X	SEGURO EXTERNO	1330
FLEETWOOD	1959	1962	A-213X	SEGURO EXTERNO	1330

CHECKER

MARATHON	1969	1981	A-213X	SEGURO EXTERNO	1330
----------	------	------	---------------	----------------	------

CHEVROLET

ASTRO	1985	1992	A-178X	SEGURO EXTERNO	1350
-------	------	------	---------------	----------------	------



ARMADORA/MODELO	AÑO INICIAL NOV 2008	AÑO FINAL ENE 2021	NO. DE PARTE Autopar	TIPO DE CRUCETA 	SERIE
-----------------	----------------------------	--------------------------	--------------------------------	---------------------	-------

CHEVROLET					
ASTRO	1990	2005	A-445-1006X	CRUCETA SEGURO INTERNO	1310
ASTRO	1985	1992	A-534G-1014X	CRUCETA SEGURO INTERNO	1344
AVALANCHE 1500	2002	2006	A-213X	CRUCETA SEGURO EXTERNO	1330
AVALANCHE 1500	2002	2006	A-534G-1014X	CRUCETA SEGURO INTERNO	1344
AVALANCHE 2500	2004	2006	A-160X	CRUCETA SEGURO EXTERNO	1410
AVALANCHE 2500	2002	2006	A-534G-1014X	CRUCETA SEGURO INTERNO	1344
BLAZER	1969	2005	A-178X	CRUCETA SEGURO EXTERNO	1350
BLAZER	1969	1991	A-200X	CRUCETA SEGURO EXTERNO	1280
BLAZER	1994	1994	A-213X	CRUCETA SEGURO EXTERNO	1330
BLAZER	1969	1991	A-252X	CRUCETA SEGURO EXTERNO	1310
BLAZER	1970	1974	A-252X	CRUCETA SEGURO EXTERNO	1310
BLAZER	1995	2005	A-445-1006X	CRUCETA SEGURO INTERNO	1310
BLAZER	1987	2005	A-534G-1014X	CRUCETA SEGURO INTERNO	1344
BROOKWOOD	1958	1970	A-200X	CRUCETA SEGURO EXTERNO	1280
BROOKWOOD	1971	1972	A-534G-1014X	CRUCETA SEGURO INTERNO	1344
C10	1975	1977	A-213X	CRUCETA SEGURO EXTERNO	1330
C10 PICKUP	1968	1974	A-213X	CRUCETA SEGURO EXTERNO	1330
C10 SUBURBAN	1968	1978	A-213X	CRUCETA SEGURO EXTERNO	1330
C10 SUBURBAN	1982	1986	A-534G-1014X	CRUCETA SEGURO INTERNO	1344
C1500	1988	1999	A-213X	CRUCETA SEGURO EXTERNO	1330
C1500 SUBURBAN	1992	1999	A-213X	CRUCETA SEGURO EXTERNO	1330
C20	1976	1977	A-213X	CRUCETA SEGURO EXTERNO	1330
C30 PICKUP	1970	1972	A-213X	CRUCETA SEGURO EXTERNO	1330
CAMARO	1982	1984	A-178X	CRUCETA SEGURO EXTERNO	1350
CAMARO	1988	1993	A-200X	CRUCETA SEGURO EXTERNO	1280
CAMARO	1988	1993	A-252X	CRUCETA SEGURO EXTERNO	1310
CAMARO	1967	1974	A-252X	CRUCETA SEGURO EXTERNO	1310
CAMARO	1975	2002	A-534G-1014X	CRUCETA SEGURO INTERNO	1344
CAPRICE	1982	1984	A-178X	CRUCETA SEGURO EXTERNO	1350
CAPRICE	1966	1968	A-200X	CRUCETA SEGURO EXTERNO	1280
CAPRICE	1966	1968	A-252X	CRUCETA SEGURO EXTERNO	1310
CAPRICE	1966	1996	A-534G-1014X	CRUCETA SEGURO INTERNO	1344
CHEVELLE	1964	1972	A-200X	CRUCETA SEGURO EXTERNO	1280
CHEVELLE	1964	1972	A-252X	CRUCETA SEGURO EXTERNO	1310
COLORADO	2004	2012	A-153X	CRUCETA SEGURO EXTERNO	1310
COLORADO	2015	2016	A-178X	CRUCETA SEGURO EXTERNO	1350
COLORADO	2004	2012	A-200X	CRUCETA SEGURO EXTERNO	1280
COLORADO	2004	2012	A-213X	CRUCETA SEGURO EXTERNO	1330
COLORADO	2004	2012	A-252X	CRUCETA SEGURO EXTERNO	1310
CORVETTE	1984	1996	A-153X	CRUCETA SEGURO EXTERNO	1310
CORVETTE	1963	1996	A-178X	CRUCETA SEGURO EXTERNO	1350
CORVETTE	1953	1996	A-200X	CRUCETA SEGURO EXTERNO	1280
CORVETTE	1980	1982	A-213X	CRUCETA SEGURO EXTERNO	1330
CORVETTE	1968	1982	A-213X	CRUCETA SEGURO EXTERNO	1330
CORVETTE	1953	1996	A-252X	CRUCETA SEGURO EXTERNO	1310
EXPRESS 1500	1996	2014	A-178X	CRUCETA SEGURO EXTERNO	1350
EXPRESS 1500	2003	2014	A-534G-1014X	CRUCETA SEGURO INTERNO	1344
EXPRESS 2500	2011	2016	A-160X	CRUCETA SEGURO EXTERNO	1410
EXPRESS 2500	1996	2010	A-178X	CRUCETA SEGURO EXTERNO	1350
EXPRESS 2500	2011	2016	A-188X	CRUCETA SEGURO EXTERNO	1480
EXPRESS 3500	2002	2016	A-160X	CRUCETA SEGURO EXTERNO	1410

ARMADORA/MODELO	AÑO INICIAL NOV 2008	AÑO FINAL ENE 2021	NO. DE PARTE Autopar®	TIPO DE CRUCETA 	SERIE
-----------------	----------------------------	--------------------------	---------------------------------	--	-------

CHEVROLET					
EXPRESS 3500	1996	2010	A-178X	CRUCETA SEGURO EXTERNO	1350
EXPRESS 3500	2010	2016	A-188X	CRUCETA SEGURO EXTERNO	1480
EXPRESS 4500	2009	2016	A-188X	CRUCETA SEGURO EXTERNO	1480
G10	1991	1995	A-213X	CRUCETA SEGURO EXTERNO	1330
G20	1976	1995	A-213X	CRUCETA SEGURO EXTERNO	1330
G30	1975	1977	A-213X	CRUCETA SEGURO EXTERNO	1330
IMPALA	1982	1984	A-178X	CRUCETA SEGURO EXTERNO	1350
IMPALA	1959	1970	A-200X	CRUCETA SEGURO EXTERNO	1280
K1500	1988	1998	A-213X	CRUCETA SEGURO EXTERNO	1330
K1500	1988	1999	A-213X	CRUCETA SEGURO EXTERNO	1330
K1500 SUBURBAN	1995	1999	A-213X	CRUCETA SEGURO EXTERNO	1330
K2500	1988	2000	A-213X	CRUCETA SEGURO EXTERNO	1330
K2500 SUBURBAN	1994	1999	A-213X	CRUCETA SEGURO EXTERNO	1330
K3500	1988	1991	A-213X	CRUCETA SEGURO EXTERNO	1330
LUV	1998	2005	A-506X	CRUCETA SEGURO INTERNO	GMC
MALIBU	1982	1983	A-178X	CRUCETA SEGURO EXTERNO	1350
MALIBU	1964	1967	A-252X	CRUCETA SEGURO EXTERNO	1310
MONTE CARLO	1970	1972	A-252X	CRUCETA SEGURO EXTERNO	1310
P10	1975	1980	A-252X	CRUCETA SEGURO EXTERNO	1310
P10 SERIES	1960	1967	A-252X	CRUCETA SEGURO EXTERNO	1310
P10 SERIES	1960	1967	A-252X	CRUCETA SEGURO EXTERNO	1310
P10 VAN	1968	1974	A-252X	CRUCETA SEGURO EXTERNO	1310
P20	1975	1981	A-252X	CRUCETA SEGURO EXTERNO	1310
P20 SERIES	1967	1967	A-252X	CRUCETA SEGURO EXTERNO	1310
P20 VAN	1968	1974	A-252X	CRUCETA SEGURO EXTERNO	1310
P30	1975	1989	A-252X	CRUCETA SEGURO EXTERNO	1310
P30 SERIES	1960	1967	A-252X	CRUCETA SEGURO EXTERNO	1310
S10	1988	1994	A-153X	CRUCETA SEGURO EXTERNO	1310
S10	1988	1994	A-200X	CRUCETA SEGURO EXTERNO	1280
S10	1994	1996	A-213X	CRUCETA SEGURO EXTERNO	1330
S10	1988	1994	A-252X	CRUCETA SEGURO EXTERNO	1310
S10	1983	2004	A-445-1006X	CRUCETA SEGURO INTERNO	1310
S10	1982	2004	A-534G-1014X	CRUCETA SEGURO INTERNO	1344
S10	1994	1996	A-621X	CRUCETA SEGURO INTERNO/EXTERNO	1330 - S44
S10 BLAZER	1988	1994	A-252X	CRUCETA SEGURO EXTERNO	1310
S10 BLAZER	1983	1994	A-445-1006X	CRUCETA SEGURO INTERNO	1310
SILVERADO	1995	1999	A-213X	CRUCETA SEGURO EXTERNO	1330
SILVERADO	1995	1999	A-534G-1014X	CRUCETA SEGURO INTERNO	1344
SILVERADO	1995	1999	A-621X	CRUCETA SEGURO INTERNO/EXTERNO	1330 - S44
SILVERADO 1500	2014	2016	A-160X	CRUCETA SEGURO EXTERNO	1410
SILVERADO 1500	2002	2013	A-178X	CRUCETA SEGURO EXTERNO	1350
SILVERADO 1500	1999	2001	A-213X	CRUCETA SEGURO EXTERNO	1330
SILVERADO 1500	1999	2007	A-213X	CRUCETA SEGURO EXTERNO	1330
SILVERADO 1500	1999	2016	A-534G-1014X	CRUCETA SEGURO INTERNO	1344
SILVERADO 1500	1999	2016	A-534G-1014X	CRUCETA SEGURO INTERNO	1344
SILVERADO 1500	1999	2001	A-621X	CRUCETA SEGURO INTERNO/EXTERNO	1330 - S44
SILVERADO 1500 CLASSIC	2007	2007	A-178X	CRUCETA SEGURO EXTERNO	1350
SILVERADO 1500 HD	2001	2006	A-178X	CRUCETA SEGURO EXTERNO	1350
SILVERADO 1500 HD	2001	2006	A-534G-1014X	CRUCETA SEGURO INTERNO	1344
SILVERADO 1500 HD CLASSIC	2007	2007	A-534G-1014X	CRUCETA SEGURO INTERNO	1344
SILVERADO 2500	1999	2005	A-160X	CRUCETA SEGURO EXTERNO	1410

ARMADORA/MODELO	AÑO INICIAL NOV 2008	AÑO FINAL ENE 2021	NO. DE PARTE Autopar®	TIPO DE CRUCETA 	SERIE
-----------------	----------------------------	--------------------------	---------------------------------	--	-------

CHRYSLER

NEW YORKER	1965	1967	A-213X	CRUCETA SEGURO EXTERNO	1330
NEW YORKER	1967	1967	A-1306X	CRUCETA SEGURO INTERNO	7260
NEW YORKER	1984	1988	A-1306X	CRUCETA SEGURO INTERNO	7260
NEWPORT	1965	1967	A-213X	CRUCETA SEGURO EXTERNO	1330
NEWPORT	1965	1967	A-1306X	CRUCETA SEGURO INTERNO	7260
TOWN & COUNTRY	1985	1991	A-1306X	CRUCETA SEGURO INTERNO	7260

DODGE

600	1984	1988	A-1306X	CRUCETA SEGURO INTERNO	7260
CARAVAN	1989	1990	A-1306X	CRUCETA SEGURO INTERNO	7260
CHALLENGER	1981	1983	A-398-1057X	CRUCETA SEGURO EXTERNO	1110
CHARGER	1966	1967	A-213X	CRUCETA SEGURO EXTERNO	1330
CHARGER	1987	1987	A-1306X	CRUCETA SEGURO INTERNO	7260
CHARGER	1966	1978	A-1306X	CRUCETA SEGURO INTERNO	7260
COLT	1985	1991	A-398-1057X	CRUCETA SEGURO EXTERNO	1110
CORONET	1966	1967	A-213X	CRUCETA SEGURO EXTERNO	1330
CORONET	1958	1976	A-1306X	CRUCETA SEGURO INTERNO	7260
D50	1979	1982	A-398-1057X	CRUCETA SEGURO EXTERNO	1110
DAKOTA	2002	2010	A-153X	CRUCETA SEGURO EXTERNO	1310
DAKOTA	2002	2010	A-200X	CRUCETA SEGURO EXTERNO	1280
DAKOTA	2000	2010	A-213X	CRUCETA SEGURO EXTERNO	1330
DAKOTA	2002	2010	A-252X	CRUCETA SEGURO EXTERNO	1310
DAKOTA	1991	1996	A-1306X	CRUCETA SEGURO INTERNO	7260
DAKOTA	1987	1999	A-1306X	CRUCETA SEGURO INTERNO	7260
DAKOTA	1992	1996	A-637X	CRUCETA SEGURO INTERNO/EXTERNO	1330 - 7290
DART	1960	1976	A-1306X	CRUCETA SEGURO INTERNO	7260
DAYTONA	1984	1991	A-1306X	CRUCETA SEGURO INTERNO	7260
DIPLOMAT	1977	1989	A-1306X	CRUCETA SEGURO INTERNO	7260
DURANGO	2000	2008	A-153X	CRUCETA SEGURO EXTERNO	1310
DURANGO	2000	2008	A-200X	CRUCETA SEGURO EXTERNO	1280
DURANGO	1998	2003	A-213X	CRUCETA SEGURO EXTERNO	1330
DURANGO	2000	2008	A-252X	CRUCETA SEGURO EXTERNO	1310
DURANGO	2004	2009	A-534G-1014X	CRUCETA SEGURO INTERNO	1344
DURANGO	1998	1999	A-637X	CRUCETA SEGURO INTERNO/EXTERNO	1330 - 7290
GRAND CARAVAN	1989	1990	A-1306X	CRUCETA SEGURO INTERNO	7260
H-100 2.4L	2002	2014	A-500X	CRUCETA SEGURO EXTERNO	DODGE
H-100 2.5L	2002	2014	A-500X	CRUCETA SEGURO EXTERNO	DODGE
MONACO	1966	1967	A-213X	CRUCETA SEGURO EXTERNO	1330
POLARA	1966	1967	A-213X	CRUCETA SEGURO EXTERNO	1330
RAM 1500	1981	1984	A-360X	CRUCETA SEGURO INTERNO/EXTERNO	1310-7260
RAM 1500	1994	2006	A-160X	CRUCETA SEGURO EXTERNO	1410
RAM 1500	2004	2010	A-178X	CRUCETA SEGURO EXTERNO	1350
RAM 1500	1994	2010	A-213X	CRUCETA SEGURO EXTERNO	1330
RAM 1500	2000	2010	A-213X	CRUCETA SEGURO EXTERNO	1330
RAM 1500	1994	1999	A-637X	CRUCETA SEGURO INTERNO/EXTERNO	1330 - 7290
RAM 1500	1994	1997	A-637X	CRUCETA SEGURO INTERNO/EXTERNO	1330 - 7290
RAM 1500	1994	1999	A-637X	CRUCETA SEGURO INTERNO/EXTERNO	1330 - 7290
RAM 1500 VAN	1995	2003	A-160X	CRUCETA SEGURO EXTERNO	1410
RAM 1500 VAN	1999	2003	A-213X	CRUCETA SEGURO EXTERNO	1330
RAM 2500	1994	1999	A-160X	CRUCETA SEGURO EXTERNO	1410
RAM 2500	2000	2002	A-178X	CRUCETA SEGURO EXTERNO	1350

ARMADORA/MODELO	AÑO INICIAL NOV 2008	AÑO FINAL ENE 2021	NO. DE PARTE Autopar®	TIPO DE CRUCETA 	SERIE
-----------------	----------------------------	--------------------------	---------------------------------	--	-------

FORD					
ECONOLINE SUPER DUTY	1996	1999	A-160X	CRUCETA SEGURO EXTERNO	1410
ELITE	1975	1976	A-213X	CRUCETA SEGURO EXTERNO	1330
ELITE	1975	1976	A-429-1010X	CRUCETA SEGURO INTERNO	1310
ESCAPE	2001	2012	A-153X	CRUCETA SEGURO EXTERNO	1310
ESCAPE	2001	2012	A-200X	CRUCETA SEGURO EXTERNO	1280
ESCAPE	2001	2012	A-252X	CRUCETA SEGURO EXTERNO	1310
EXCURSION	2003	2005	A-160X	CRUCETA SEGURO EXTERNO	1410
EXCURSION	2000	2005	A-160X	CRUCETA SEGURO EXTERNO	1410
EXCURSION	2000	2005	A-178X	CRUCETA SEGURO EXTERNO	1350
EXCURSION	2000	2003	A-178X	CRUCETA SEGURO EXTERNO	1350
EXCURSION	2000	2001	A-213X	CRUCETA SEGURO EXTERNO	1330
EXPEDITION	1997	2016	A-178X	CRUCETA SEGURO EXTERNO	1350
EXPEDITION	1997	2006	A-213X	CRUCETA SEGURO EXTERNO	1330
EXPEDITION	1997	2001	A-213X	CRUCETA SEGURO EXTERNO	1330
EXPLORER	1991	2010	A-153X	CRUCETA SEGURO EXTERNO	1310
EXPLORER	2009	2010	A-178X	CRUCETA SEGURO EXTERNO	1350
EXPLORER	1991	2010	A-200X	CRUCETA SEGURO EXTERNO	1280
EXPLORER	1991	1996	A-200X	CRUCETA SEGURO EXTERNO	1280
EXPLORER	1991	2010	A-213X	CRUCETA SEGURO EXTERNO	1330
EXPLORER	1991	2010	A-252X	CRUCETA SEGURO EXTERNO	1310
EXPLORER	1991	1996	A-252X	CRUCETA SEGURO EXTERNO	1310
EXPLORER SPORT TRAC	2007	2008	A-153X	CRUCETA SEGURO EXTERNO	1310
EXPLORER SPORT TRAC	2007	2010	A-200X	CRUCETA SEGURO EXTERNO	1280
EXPLORER SPORT TRAC	2002	2005	A-213X	CRUCETA SEGURO EXTERNO	1330
EXPLORER SPORT TRAC	2001	2005	A-213X	CRUCETA SEGURO EXTERNO	1330
EXPLORER SPORT TRAC	2007	2010	A-252X	CRUCETA SEGURO EXTERNO	1310
F SERIES	1948	1959	A-200X	CRUCETA SEGURO EXTERNO	1280
F-100	1973	1983	A-213X	CRUCETA SEGURO EXTERNO	1330
F-100	1976	1978	A-353-1034X	CRUCETA SEGURO EXTERNO	1310 - 1330
F-150	1975	1978	A-153X	CRUCETA SEGURO EXTERNO	1310
F-150	2011	2014	A-160X	CRUCETA SEGURO EXTERNO	1410
F-150	1997	2014	A-178X	CRUCETA SEGURO EXTERNO	1350
F-150	1975	2003	A-200X	CRUCETA SEGURO EXTERNO	1280
F-150	1976	2007	A-213X	CRUCETA SEGURO EXTERNO	1330
F-150	1975	2003	A-213X	CRUCETA SEGURO EXTERNO	1330
F-150	1975	2003	A-252X	CRUCETA SEGURO EXTERNO	1310
F-150	1975	1978	A-353-1034X	CRUCETA SEGURO EXTERNO	1310 - 1330
F-150 HERITAGE	2004	2004	A-178X	CRUCETA SEGURO EXTERNO	1350
F-150 HERITAGE	2004	2004	A-200X	CRUCETA SEGURO EXTERNO	1280
F-150 HERITAGE	2004	2004	A-213X	CRUCETA SEGURO EXTERNO	1330
F-150 HERITAGE	2004	2004	A-213X	CRUCETA SEGURO EXTERNO	1330
F-250	1975	1978	A-153X	CRUCETA SEGURO EXTERNO	1310
F-250	1975	1978	A-200X	CRUCETA SEGURO EXTERNO	1280
F-250	1978	1999	A-213X	CRUCETA SEGURO EXTERNO	1330
F-250	1977	1978	A-213X	CRUCETA SEGURO EXTERNO	1330
F-250	1975	1998	A-213X	CRUCETA SEGURO EXTERNO	1330
F-250	1975	1978	A-252X	CRUCETA SEGURO EXTERNO	1310
F-250	1975	1978	A-252X	CRUCETA SEGURO EXTERNO	1310
F-250	1975	1977	A-353-1034X	CRUCETA SEGURO EXTERNO	1310 - 1330
F-250	1975	1978	A-353-1034X	CRUCETA SEGURO EXTERNO	1310 - 1330
F-250	1975	1977	A-353-1034X	CRUCETA SEGURO EXTERNO	1310 - 1330



ARMADORA/MODELO	AÑO INICIAL NOV 2008	AÑO FINAL ENE 2021	NO. DE PARTE Autopar	TIPO DE CRUCETA 	SERIE
FORD					
F-250 SUPER DUTY	2009	2016	A-160X	CRUCETA SEGURO EXTERNO	1410
F-250 SUPER DUTY	1999	2008	A-178X	CRUCETA SEGURO EXTERNO	1350
F-350	1975	1978	A-153X	CRUCETA SEGURO EXTERNO	1310
F-350	1975	1997	A-178X	CRUCETA SEGURO EXTERNO	1350
F-350	1975	1976	A-200X	CRUCETA SEGURO EXTERNO	1280
F-350	1985	1985	A-213X	CRUCETA SEGURO EXTERNO	1330
F-350	1979	1997	A-213X	CRUCETA SEGURO EXTERNO	1330
F-350	1975	1997	A-213X	CRUCETA SEGURO EXTERNO	1330
F-350	1975	1976	A-252X	CRUCETA SEGURO EXTERNO	1310
F-350	1988	1988	A-621X	CRUCETA SEGURO INTERNO/EXTERNO	1330 - S44
F-350 SUPER DUTY	2009	2016	A-160X	CRUCETA SEGURO EXTERNO	1410
F-350 SUPER DUTY	1999	2016	A-160X	CRUCETA SEGURO EXTERNO	1410
F-350 SUPER DUTY	1999	2016	A-178X	CRUCETA SEGURO EXTERNO	1350
F-350 SUPER DUTY	2009	2016	A-188X	CRUCETA SEGURO EXTERNO	1480
F-450 SUPER DUTY	2009	2016	A-160X	CRUCETA SEGURO EXTERNO	1410
F-450 SUPER DUTY	1999	2008	A-178X	CRUCETA SEGURO EXTERNO	1350
F-450 SUPER DUTY	1999	2016	A-188X	CRUCETA SEGURO EXTERNO	1480
F-550 SUPER DUTY	2009	2016	A-160X	CRUCETA SEGURO EXTERNO	1410
F-550 SUPER DUTY	1999	2008	A-178X	CRUCETA SEGURO EXTERNO	1350
F-550 SUPER DUTY	1999	2016	A-188X	CRUCETA SEGURO EXTERNO	1480
F650 SUPER DUTY	1999	2002	ASPL90X	CRUCETA SEGURO EXTERNO	SPL90
FAIRLANE	1956	1960	A-200X	CRUCETA SEGURO EXTERNO	1280
FAIRLANE	1966	1970	A-213X	CRUCETA SEGURO EXTERNO	1330
FAIRLANE	1956	1960	A-252X	CRUCETA SEGURO EXTERNO	1310
FAIRLANE	1961	1970	A-429-1010X	CRUCETA SEGURO INTERNO	1310
FAIRLANE	1964	1965	A-433-1012X	CRUCETA SEGURO INTERNO	P55
FAIRMONT	1978	1983	A-429-1010X	CRUCETA SEGURO INTERNO	1310
FALCON	1963	1970	A-429-1010X	CRUCETA SEGURO INTERNO	1310
FALCON	1964	1964	A-433-1012X	CRUCETA SEGURO INTERNO	P55
GALAXIE	1959	1960	A-200X	CRUCETA SEGURO EXTERNO	1280
GALAXIE	1966	1967	A-213X	CRUCETA SEGURO EXTERNO	1330
GALAXIE	1959	1960	A-252X	CRUCETA SEGURO EXTERNO	1310
GALAXIE	1964	1965	A-433-1012X	CRUCETA SEGURO INTERNO	P55
GALAXIE 500	1966	1974	A-213X	CRUCETA SEGURO EXTERNO	1330
GALAXIE 500	1964	1965	A-433-1012X	CRUCETA SEGURO INTERNO	P55
GRAN TORINO	1972	1976	A-213X	CRUCETA SEGURO EXTERNO	1330
GRANADA	1975	1978	A-213X	CRUCETA SEGURO EXTERNO	1330
GRANADA	1975	1982	A-429-1010X	CRUCETA SEGURO INTERNO	1310
GRAND MARQUIS	2003	2004	A-178X	CRUCETA SEGURO EXTERNO	1350
GRAND MARQUIS	1995	2002	A-213X	CRUCETA SEGURO EXTERNO	1330
LTD	1966	1986	A-213X	CRUCETA SEGURO EXTERNO	1330
LTD	1965	1986	A-429-1010X	CRUCETA SEGURO INTERNO	1310
LTD	1965	1965	A-433-1012X	CRUCETA SEGURO INTERNO	P55
LTD CROWN VICTORIA	1990	1991	A-200X	CRUCETA SEGURO EXTERNO	1280
LTD CROWN VICTORIA	1987	1991	A-213X	CRUCETA SEGURO EXTERNO	1330
LTD CROWN VICTORIA	1990	1991	A-252X	CRUCETA SEGURO EXTERNO	1310
LTD II	1977	1979	A-213X	CRUCETA SEGURO EXTERNO	1330
MAINLINE	1956	1956	A-200X	CRUCETA SEGURO EXTERNO	1280
MAINLINE	1956	1956	A-252X	CRUCETA SEGURO EXTERNO	1310
MUSTANG	1987	1995	A-153X	CRUCETA SEGURO EXTERNO	1310
MUSTANG	2003	2016	A-178X	CRUCETA SEGURO EXTERNO	1350

ARMADORA/MODELO	AÑO INICIAL NOV 2008	AÑO FINAL ENE 2021	NO. DE PARTE Autopar®	TIPO DE CRUCETA 	SERIE
-----------------	----------------------------	--------------------------	---------------------------------	--	-------

FORD					
MUSTANG	1987	1995	A-200X	CRUCETA SEGURO EXTERNO	1280
MUSTANG	1967	2004	A-213X	CRUCETA SEGURO EXTERNO	1330
MUSTANG	1987	1995	A-252X	CRUCETA SEGURO EXTERNO	1310
MUSTANG II	1974	1978	A-429-1010X	CRUCETA SEGURO INTERNO	1310
P-100	1960	1973	A-252X	CRUCETA SEGURO EXTERNO	1310
P-350	1975	1976	A-213X	CRUCETA SEGURO EXTERNO	1330
P-350	1960	1974	A-252X	CRUCETA SEGURO EXTERNO	1310
RANCH WAGON	1956	1960	A-200X	CRUCETA SEGURO EXTERNO	1280
RANCH WAGON	1966	1974	A-213X	CRUCETA SEGURO EXTERNO	1330
RANCH WAGON	1956	1960	A-252X	CRUCETA SEGURO EXTERNO	1310
RANCH WAGON	1964	1965	A-433-1012X	CRUCETA SEGURO INTERNO	P55
RANCHERO	1957	1960	A-200X	CRUCETA SEGURO EXTERNO	1280
RANCHERO	1976	1979	A-213X	CRUCETA SEGURO EXTERNO	1330
RANCHERO	1957	1960	A-252X	CRUCETA SEGURO EXTERNO	1310
RANCHERO	1961	1977	A-429-1010X	CRUCETA SEGURO INTERNO	1310
RANCHERO	1964	1975	A-433-1012X	CRUCETA SEGURO INTERNO	P55
RANGER	1990	2011	A-153X	CRUCETA SEGURO EXTERNO	1310
RANGER	1990	2011	A-200X	CRUCETA SEGURO EXTERNO	1280
RANGER	1998	1998	A-213X	CRUCETA SEGURO EXTERNO	1330
RANGER	1990	2011	A-252X	CRUCETA SEGURO EXTERNO	1310
RANGER	1987	1989	A-437G-1741X	CRUCETA SEGURO EXTERNO	1210
RANGER	1983	1984	A-437G-1741X	CRUCETA SEGURO EXTERNO	1210
RANGER	1983	1989	A-437G-1741X	CRUCETA SEGURO EXTERNO	1210
RANGER	1987	1989	A-429-1010X	CRUCETA SEGURO INTERNO	1310
RANGER ARGENTINA	2012	2020	A-502X	CRUCETA SEGURO EXTERNO	NISSAN
TEMPO	1987	1991	A-437G-1741X	CRUCETA SEGURO EXTERNO	1210
TEMPO	1987	1991	A-437G-1741X	CRUCETA SEGURO EXTERNO	1210
THUNDERBIRD	1989	1993	A-200X	CRUCETA SEGURO EXTERNO	1280
THUNDERBIRD	1972	1996	A-213X	CRUCETA SEGURO EXTERNO	1330
THUNDERBIRD	1989	1993	A-252X	CRUCETA SEGURO EXTERNO	1310
THUNDERBIRD	1980	1988	A-429-1010X	CRUCETA SEGURO INTERNO	1310
TORINO	1968	1976	A-213X	CRUCETA SEGURO EXTERNO	1330
TORINO	1968	1976	A-429-1010X	CRUCETA SEGURO INTERNO	1310

GEO					
TRACKER	1989	1997	A-398-1057X	CRUCETA SEGURO EXTERNO	1110
TRACKER	1989	1997	A-398-1057X	CRUCETA SEGURO EXTERNO	1110

GMC					
C15	1975	1977	A-213X	CRUCETA SEGURO EXTERNO	1330
C15 SUBURBAN	1975	1977	A-213X	CRUCETA SEGURO EXTERNO	1330
C15/C1500 PICKUP	1968	1974	A-213X	CRUCETA SEGURO EXTERNO	1330
C15/C1500 SUBURBAN	1968	1974	A-213X	CRUCETA SEGURO EXTERNO	1330
C1500	1988	1999	A-213X	CRUCETA SEGURO EXTERNO	1330
C1500 SUBURBAN	1992	1999	A-213X	CRUCETA SEGURO EXTERNO	1330
C1500 SUBURBAN	1992	1999	A-621X	CRUCETA SEGURO INTERNO/EXTERNO	1330 - S44
C25	1976	1977	A-213X	CRUCETA SEGURO EXTERNO	1330
C31003	1979	1983	A-002X	CRUCETA SEGURO EXTERNO	1350 - 1410
C35/C3500 PICKUP	1968	1972	A-213X	CRUCETA SEGURO EXTERNO	1330
CANYON	2004	2012	A-153X	CRUCETA SEGURO EXTERNO	1310

ARMADORA/MODELO	AÑO INICIAL NOV 2008	AÑO FINAL ENE 2021	NO. DE PARTE Autopar®	TIPO DE CRUCETA 	SERIE
-----------------	----------------------------	--------------------------	---------------------------------	--	-------

GMC					
SAVANA 4500	2009	2016	A-188X	CRUCETA SEGURO EXTERNO	1480
SIERRA 1500	2014	2016	A-160X	CRUCETA SEGURO EXTERNO	1410
SIERRA 1500	2002	2013	A-178X	CRUCETA SEGURO EXTERNO	1350
SIERRA 1500	1999	2001	A-213X	CRUCETA SEGURO EXTERNO	1330
SIERRA 1500	1999	2007	A-213X	CRUCETA SEGURO EXTERNO	1330
SIERRA 1500	1999	2016	A-534G-1014X	CRUCETA SEGURO INTERNO	1344
SIERRA 1500	1999	2016	A-534G-1014X	CRUCETA SEGURO INTERNO	1344
SIERRA 1500	1999	2001	A-621X	CRUCETA SEGURO INTERNO/EXTERNO	1330 - S44
SIERRA 1500	1999	2007	A-621X	CRUCETA SEGURO INTERNO/EXTERNO	1330 - S44
SIERRA 1500 HD	2001	2006	A-178X	CRUCETA SEGURO EXTERNO	1350
SIERRA 1500 HD	2001	2006	A-534G-1014X	CRUCETA SEGURO INTERNO	1344
SIERRA 1500 HD CLASSIC	2007	2007	A-178X	CRUCETA SEGURO EXTERNO	1350
SIERRA 1500 HD CLASSIC	2007	2007	A-534G-1014X	CRUCETA SEGURO INTERNO	1344
SIERRA 2500	1999	2004	A-160X	CRUCETA SEGURO EXTERNO	1410
SIERRA 2500	1999	2004	A-178X	CRUCETA SEGURO EXTERNO	1350
SIERRA 2500	1999	2004	A-534G-1014X	CRUCETA SEGURO INTERNO	1344
SIERRA 2500 HD	2001	2016	A-160X	CRUCETA SEGURO EXTERNO	1410
SIERRA 2500 HD	2001	2004	A-178X	CRUCETA SEGURO EXTERNO	1350
SIERRA 2500 HD	2001	2016	A-188X	CRUCETA SEGURO EXTERNO	1480
SIERRA 2500 HD	2001	2016	A-534G-1014X	CRUCETA SEGURO INTERNO	1344
SIERRA 2500 HD CLASSIC	2007	2007	A-188X	CRUCETA SEGURO EXTERNO	1480
SIERRA 3500	2001	2006	A-160X	CRUCETA SEGURO EXTERNO	1410
SIERRA 3500	2001	2001	A-178X	CRUCETA SEGURO EXTERNO	1350
SIERRA 3500	2003	2006	A-188X	CRUCETA SEGURO EXTERNO	1480
SIERRA 3500	2001	2006	A-534G-1014X	CRUCETA SEGURO INTERNO	1344
SIERRA 3500 CLASSIC	2007	2007	A-160X	CRUCETA SEGURO EXTERNO	1410
SIERRA 3500 CLASSIC	2007	2007	A-188X	CRUCETA SEGURO EXTERNO	1480
SIERRA 3500 CLASSIC	2007	2007	A-534G-1014X	CRUCETA SEGURO INTERNO	1344
SIERRA 3500 HD	2007	2016	A-160X	CRUCETA SEGURO EXTERNO	1410
SIERRA 3500 HD	2007	2016	A-188X	CRUCETA SEGURO EXTERNO	1480
SIERRA 3500 HD	2007	2016	A-534G-1014X	CRUCETA SEGURO INTERNO	1344
SONOMA	1991	1994	A-153X	CRUCETA SEGURO EXTERNO	1310
SONOMA	1991	1994	A-200X	CRUCETA SEGURO EXTERNO	1280
SONOMA	1994	1996	A-213X	CRUCETA SEGURO EXTERNO	1330
SONOMA	1991	1994	A-252X	CRUCETA SEGURO EXTERNO	1310
SONOMA	1991	2004	A-445-1006X	CRUCETA SEGURO INTERNO	1310
SONOMA	1991	2004	A-534G-1014X	CRUCETA SEGURO INTERNO	1344
SONOMA	1994	1996	A-621X	CRUCETA SEGURO INTERNO/EXTERNO	1330 - S44
SPRINT	1971	1977	A-200X	CRUCETA SEGURO EXTERNO	1280
SPRINT	1971	1977	A-252X	CRUCETA SEGURO EXTERNO	1310
SPRINT	1971	1977	A-534G-1014X	CRUCETA SEGURO INTERNO	1344
SPRINT	1971	1972	A-621X	CRUCETA SEGURO INTERNO/EXTERNO	1330 - S44
SUBURBAN EJE IMPORTADO	1990	1993	A-009X	CRUCETA SEGURO EXTERNO	1330
SUBURBAN EJE NACIONAL	1990	1995	A-008X	CRUCETA SEGURO EXTERNO	1310 - 1330
SYCLONE	1991	1991	A-200X	CRUCETA SEGURO EXTERNO	1280
SYCLONE	1991	1991	A-252X	CRUCETA SEGURO EXTERNO	1310
SYCLONE	1991	1991	A-445-1006X	CRUCETA SEGURO INTERNO	1310
SYCLONE	1991	1991	A-534G-1014X	CRUCETA SEGURO INTERNO	1344
TYPHOON	1992	1993	A-200X	CRUCETA SEGURO EXTERNO	1280
TYPHOON	1992	1993	A-445-1006X	CRUCETA SEGURO INTERNO	1310
TYPHOON	1992	1993	A-534G-1014X	CRUCETA SEGURO INTERNO	1344

ARMADORA/MODELO	AÑO INICIAL NOV 2008	AÑO FINAL ENE 2021	NO. DE PARTE Autopar®	TIPO DE CRUCETA 	SERIE
-----------------	----------------------------	--------------------------	---------------------------------	--	-------

ISUZU					
HOMBRE	1996	2000	A-534G-1014X	CRUCETA SEGURO INTERNO	1344
I-280	2006	2006	A-213X	CRUCETA SEGURO EXTERNO	1330
I-290	2007	2008	A-213X	CRUCETA SEGURO EXTERNO	1330
I-350	2006	2006	A-213X	CRUCETA SEGURO EXTERNO	1330
I-370	2007	2008	A-213X	CRUCETA SEGURO EXTERNO	1330
PICKUP	1981	1987	A-341-1027X	CRUCETA SEGURO EXTERNO	1210
PICKUP	1981	1987	A-341-1027X	CRUCETA SEGURO EXTERNO	1210
RODEO	1998	2004	A-252X	CRUCETA SEGURO EXTERNO	1310
RODEO	1991	2004	A-252X	CRUCETA SEGURO EXTERNO	1310
RODEO SPORT	2001	2003	A-252X	CRUCETA SEGURO EXTERNO	1310
RODEO SPORT	2001	2003	A-252X	CRUCETA SEGURO EXTERNO	1310
TROOPER	1987	1987	A-341-1027X	CRUCETA SEGURO EXTERNO	1210
TROOPER	1984	1986	A-341-1027X	CRUCETA SEGURO EXTERNO	1210

JEEP					
CHEROKEE	1974	2001	A-153X	CRUCETA SEGURO EXTERNO	1310
CHEROKEE	1974	2001	A-200X	CRUCETA SEGURO EXTERNO	1280
CHEROKEE	1974	2001	A-252X	CRUCETA SEGURO EXTERNO	1310
CHEROKEE	1974	2001	A-252X	CRUCETA SEGURO EXTERNO	1310
CHEROKEE	1974	1980	A-1306X	CRUCETA SEGURO INTERNO	7260
CJ5	1982	1983	A-213X	CRUCETA SEGURO EXTERNO	1330
CJ7	1982	1986	A-213X	CRUCETA SEGURO EXTERNO	1330
COMANCHE	1986	1992	A-153X	CRUCETA SEGURO EXTERNO	1310
COMANCHE	1986	1992	A-200X	CRUCETA SEGURO EXTERNO	1280
COMMANDO	1966	1973	A-200X	CRUCETA SEGURO EXTERNO	1280
GLADIATOR	1963	1969	A-200X	CRUCETA SEGURO EXTERNO	1280
GRAND CHEROKEE	1993	2004	A-153X	CRUCETA SEGURO EXTERNO	1310
GRAND CHEROKEE	1993	2004	A-200X	CRUCETA SEGURO EXTERNO	1280
GRAND CHEROKEE	2002	2004	A-213X	CRUCETA SEGURO EXTERNO	1330
GRAND CHEROKEE	1993	2004	A-252X	CRUCETA SEGURO EXTERNO	1310
GRAND CHEROKEE	1993	2004	A-252X	CRUCETA SEGURO EXTERNO	1310
GRAND WAGONEER	1984	1993	A-200X	CRUCETA SEGURO EXTERNO	1280
LIBERTY	2002	2007	A-153X	CRUCETA SEGURO EXTERNO	1310
LIBERTY	2002	2007	A-200X	CRUCETA SEGURO EXTERNO	1280
LIBERTY	2002	2007	A-213X	CRUCETA SEGURO EXTERNO	1330
LIBERTY	2002	2007	A-252X	CRUCETA SEGURO EXTERNO	1310
SCRAMBLER	1982	1985	A-213X	CRUCETA SEGURO EXTERNO	1330
TJ	2003	2006	A-213X	CRUCETA SEGURO EXTERNO	1330
TJ	2003	2006	A-534G-1014X	CRUCETA SEGURO INTERNO	1344
TJ	2003	2006	A-621X	CRUCETA SEGURO INTERNO/EXTERNO	1330 - S44
WAGONEER	1970	1983	A-153X	CRUCETA SEGURO EXTERNO	1310
WAGONEER	1963	1990	A-252X	CRUCETA SEGURO EXTERNO	1310
WAGONEER	1970	1974	A-1306X	CRUCETA SEGURO INTERNO	7260
WAGONEER	1966	1980	A-1306X	CRUCETA SEGURO INTERNO	7260
WRANGLER	1997	2006	A-153X	CRUCETA SEGURO EXTERNO	1310
WRANGLER	1987	2006	A-200X	CRUCETA SEGURO EXTERNO	1280
WRANGLER	2003	2006	A-213X	CRUCETA SEGURO EXTERNO	1330
WRANGLER	1987	1995	A-213X	CRUCETA SEGURO EXTERNO	1330
WRANGLER	1987	2006	A-252X	CRUCETA SEGURO EXTERNO	1310
WRANGLER	2003	2006	A-534G-1014X	CRUCETA SEGURO INTERNO	1344

ARMADORA/MODELO	AÑO INICIAL NOV 2008	AÑO FINAL ENE 2021	NO. DE PARTE Autopar®	TIPO DE CRUCETA 	SERIE
-----------------	----------------------------	--------------------------	---------------------------------	--	-------

MAZDA

B2500	1998	2001	A-213X	CRUCETA SEGURO EXTERNO	1330
B2600	1987	1993	A-384-1029X	CRUCETA SEGURO INTERNO	1310
B3000	1994	2002	A-153X	CRUCETA SEGURO EXTERNO	1310
B3000	1994	1997	A-200X	CRUCETA SEGURO EXTERNO	1280
B3000	1998	2007	A-213X	CRUCETA SEGURO EXTERNO	1330
B3000	1994	2002	A-252X	CRUCETA SEGURO EXTERNO	1310
B4000	1994	2009	A-153X	CRUCETA SEGURO EXTERNO	1310
B4000	1994	1997	A-200X	CRUCETA SEGURO EXTERNO	1280
B4000	1998	2009	A-213X	CRUCETA SEGURO EXTERNO	1330
B4000	1994	2009	A-252X	CRUCETA SEGURO EXTERNO	1310
MPV	1989	1995	A-384-1029X	CRUCETA SEGURO INTERNO	1310
NAVAJO	1991	1994	A-153X	CRUCETA SEGURO EXTERNO	1310
NAVAJO	1991	1994	A-200X	CRUCETA SEGURO EXTERNO	1280
NAVAJO	1991	1994	A-252X	CRUCETA SEGURO EXTERNO	1310

MERCEDES BENZ

ML320	2002	2003	A-200X	CRUCETA SEGURO EXTERNO	1280
ML320	2002	2003	A-252X	CRUCETA SEGURO EXTERNO	1310
ML350	2003	2005	A-200X	CRUCETA SEGURO EXTERNO	1280
ML350	2003	2005	A-252X	CRUCETA SEGURO EXTERNO	1310
ML500	2002	2005	A-200X	CRUCETA SEGURO EXTERNO	1280
ML500	2002	2005	A-252X	CRUCETA SEGURO EXTERNO	1310
ML55 AMG	2002	2003	A-200X	CRUCETA SEGURO EXTERNO	1280
ML55 AMG	2002	2003	A-252X	CRUCETA SEGURO EXTERNO	1310

MERCURY

BOBCAT	1975	1980	A-429-1010X	CRUCETA SEGURO INTERNO	1310
CALIENTE	1966	1967	A-213X	CRUCETA SEGURO EXTERNO	1330
CALIENTE	1964	1967	A-429-1010X	CRUCETA SEGURO INTERNO	1310
CAPRI	1979	1986	A-429-1010X	CRUCETA SEGURO INTERNO	1310
COLONY PARK	1964	1991	A-213X	CRUCETA SEGURO EXTERNO	1330
COLONY PARK	1960	1960	A-353-1034X	CRUCETA SEGURO EXTERNO	1310 - 1330
COLONY PARK	1961	1989	A-429-1010X	CRUCETA SEGURO INTERNO	1310
COLONY PARK	1963	1963	A-433-1012X	CRUCETA SEGURO INTERNO	P55
COMET	1966	1970	A-213X	CRUCETA SEGURO EXTERNO	1330
COMET	1963	1977	A-429-1010X	CRUCETA SEGURO INTERNO	1310
COUGAR	1989	1993	A-153X	CRUCETA SEGURO EXTERNO	1310
COUGAR	1967	1997	A-213X	CRUCETA SEGURO EXTERNO	1330
COUGAR	1967	1988	A-429-1010X	CRUCETA SEGURO INTERNO	1310
CYCLONE	1966	1970	A-213X	CRUCETA SEGURO EXTERNO	1330
CYCLONE	1964	1971	A-429-1010X	CRUCETA SEGURO INTERNO	1310
GRAND MARQUIS	2007	2011	A-178X	CRUCETA SEGURO EXTERNO	1350
GRAND MARQUIS	1990	1994	A-200X	CRUCETA SEGURO EXTERNO	1280
GRAND MARQUIS	1975	2006	A-213X	CRUCETA SEGURO EXTERNO	1330
GRAND MARQUIS	1977	1989	A-429-1010X	CRUCETA SEGURO INTERNO	1310
MARAUDER	1964	2004	A-213X	CRUCETA SEGURO EXTERNO	1330
MARAUDER	1965	1965	A-429-1010X	CRUCETA SEGURO INTERNO	1310
MARAUDER	1963	1963	A-433-1012X	CRUCETA SEGURO INTERNO	P55
MARINER	2005	2011	A-200X	CRUCETA SEGURO EXTERNO	1280
MARQUIS	1967	1986	A-213X	CRUCETA SEGURO EXTERNO	1330
MARQUIS	1977	1986	A-429-1010X	CRUCETA SEGURO INTERNO	1310



ARMADORA/MODELO	AÑO INICIAL NOV 2008	AÑO FINAL ENE 2021	NO. DE PARTE Autopar 11 11 11 11 11 11 11 11 11 11 11 11 11 11 11 11	TIPO DE CRUCETA 	SERIE
-----------------	----------------------------	--------------------------	---	--	-------

MERCURY					
MONARCH	1975	1978	A-213X	CRUCETA SEGURO EXTERNO	1330
MONARCH	1975	1980	A-429-1010X	CRUCETA SEGURO INTERNO	1310
MONTCLAIR	1964	1968	A-213X	CRUCETA SEGURO EXTERNO	1330
MONTCLAIR	1960	1960	A-353-1034X	CRUCETA SEGURO EXTERNO	1310 - 1330
MONTCLAIR	1965	1965	A-429-1010X	CRUCETA SEGURO INTERNO	1310
MONTEGO	1968	1976	A-213X	CRUCETA SEGURO EXTERNO	1330
MONTEGO	1968	1976	A-429-1010X	CRUCETA SEGURO INTERNO	1310
MONTEREY	1955	1960	A-200X	CRUCETA SEGURO EXTERNO	1280
MONTEREY	1964	1974	A-213X	CRUCETA SEGURO EXTERNO	1330
MONTEREY	1955	1960	A-252X	CRUCETA SEGURO EXTERNO	1310
MONTEREY	1960	1960	A-353-1034X	CRUCETA SEGURO EXTERNO	1310 - 1330
MONTEREY	1961	1965	A-429-1010X	CRUCETA SEGURO INTERNO	1310
MONTEREY	1963	1963	A-433-1012X	CRUCETA SEGURO INTERNO	P55
MOUNTAINEER	2009	2010	A-178X	CRUCETA SEGURO EXTERNO	1350
MOUNTAINEER	1997	2010	A-200X	CRUCETA SEGURO EXTERNO	1280
MOUNTAINEER	1997	2010	A-213X	CRUCETA SEGURO EXTERNO	1330
MOUNTAINEER	1997	2010	A-252X	CRUCETA SEGURO EXTERNO	1310
TOPAZ	1987	1991	A-437G-1741X	CRUCETA SEGURO EXTERNO	1210
TOPAZ	1987	1991	A-437G-1741X	CRUCETA SEGURO EXTERNO	1210
TURNPIKE CRUISER	1957	1957	A-252X	CRUCETA SEGURO EXTERNO	1310
ZEPHYR	1978	1983	A-429-1010X	CRUCETA SEGURO INTERNO	1310

MG					
MG MGB	1962	1981	A-341-1027X	CRUCETA SEGURO EXTERNO	1210
MG MGC	1968	1969	A-200X	CRUCETA SEGURO EXTERNO	1280
MG MIDGET	1962	1979	A-341-1027X	CRUCETA SEGURO EXTERNO	1210

MITSUBISHI					
L200	2008	2019	A-526X	CRUCETA SEGURO INTERNO	MITSUBISHI
MONTERO	1999	2002	A-398-1057X	CRUCETA SEGURO EXTERNO	1110
MONTERO SPORT	1997	2004	A-398-1057X	CRUCETA SEGURO EXTERNO	1110
OUTLANDER	2003	2006	A-398-1057X	CRUCETA SEGURO EXTERNO	1110
RAIDER	2006	2009	A-200X	CRUCETA SEGURO EXTERNO	1280
RAIDER	2006	2009	A-213X	CRUCETA SEGURO EXTERNO	1330
RAIDER	2006	2009	A-252X	CRUCETA SEGURO EXTERNO	1310

NISSAN					
510	1968	1973	A-393-1051X	CRUCETA SEGURO INTERNO	1310
610	1973	1976	A-391-1052X	CRUCETA SEGURO INTERNO	NISSAN
610	1973	1976	A-393-1051X	CRUCETA SEGURO INTERNO	1310
620	1975	1979	A-391-1052X	CRUCETA SEGURO INTERNO	NISSAN
710	1974	1977	A-391-1052X	CRUCETA SEGURO INTERNO	NISSAN
720	1980	1985	A-391-1052X	CRUCETA SEGURO INTERNO	NISSAN
720	1984	1985	A-393-1051X	CRUCETA SEGURO INTERNO	1310
810	1977	1981	A-393-1051X	CRUCETA SEGURO INTERNO	1310
200SX	1978	1983	A-393-1051X	CRUCETA SEGURO INTERNO	1310
240Z	1971	1973	A-391-1052X	CRUCETA SEGURO INTERNO	NISSAN
240Z	1971	1973	A-393-1051X	CRUCETA SEGURO INTERNO	1310

ARMADORA/MODELO	AÑO INICIAL NOV 2008	AÑO FINAL ENE 2021	NO. DE PARTE Autopar®	TIPO DE CRUCETA 	SERIE
NISSAN					
260Z	1974	1974	A-391-1052X	CRUCETA SEGURO INTERNO	NISSAN
260Z	1974	1975	A-393-1051X	CRUCETA SEGURO INTERNO	1310
280Z	1975	1977	A-391-1052X	CRUCETA SEGURO INTERNO	NISSAN
280Z	1975	1978	A-393-1051X	CRUCETA SEGURO INTERNO	1310
280ZX	1979	1983	A-393-1051X	CRUCETA SEGURO INTERNO	1310
521 PICKUP	1969	1972	A-391-1052X	CRUCETA SEGURO INTERNO	NISSAN
620 PICKUP	1972	1974	A-391-1052X	CRUCETA SEGURO INTERNO	NISSAN
ARMADA	2005	2015	A-153X	CRUCETA SEGURO EXTERNO	1310
ARMADA	2007	2015	A-160X	CRUCETA SEGURO EXTERNO	1410
ARMADA	2005	2015	A-178X	CRUCETA SEGURO EXTERNO	1350
ARMADA	2005	2015	A-200X	CRUCETA SEGURO EXTERNO	1280
ARMADA	2005	2015	A-252X	CRUCETA SEGURO EXTERNO	1310
CABSTAR	2008	2014	A-509X	CRUCETA SEGURO EXTERNO	NISSAN
D21	1994	2008	A-153X	CRUCETA SEGURO EXTERNO	1310
D21	1987	1994	A-200X	CRUCETA SEGURO EXTERNO	1280
D21	1987	1994	A-252X	CRUCETA SEGURO EXTERNO	1310
D21	1988	1989	A-391-1052X	CRUCETA SEGURO INTERNO	NISSAN
D21	1986	1994	A-393-1051X	CRUCETA SEGURO INTERNO	1310
D21 AMERICANA	1986	1990	A-153X	CRUCETA SEGURO EXTERNO	1310
FRONTIER	1998	2016	A-153X	CRUCETA SEGURO EXTERNO	1310
FRONTIER	1998	2016	A-200X	CRUCETA SEGURO EXTERNO	1280
FRONTIER	2005	2016	A-213X	CRUCETA SEGURO EXTERNO	1330
FRONTIER	1998	2016	A-252X	CRUCETA SEGURO EXTERNO	1310
NP300 D23	2015	2020	A-502X	CRUCETA SEGURO EXTERNO	NISSAN
NV350	2013	2019	A-519X	CRUCETA SEGURO INTERNO	NISSAN
PATHFINDER	1987	2001	A-153X	CRUCETA SEGURO EXTERNO	1310
PATHFINDER	2009	2010	A-178X	CRUCETA SEGURO EXTERNO	1350
PATHFINDER	2005	2012	A-200X	CRUCETA SEGURO EXTERNO	1280
PATHFINDER	2005	2012	A-213X	CRUCETA SEGURO EXTERNO	1330
PATHFINDER	2005	2012	A-252X	CRUCETA SEGURO EXTERNO	1310
PATHFINDER	1987	2004	A-393-1051X	CRUCETA SEGURO INTERNO	1310
PICKUP	1995	1997	A-200X	CRUCETA SEGURO EXTERNO	1280
PICKUP	1995	1997	A-252X	CRUCETA SEGURO EXTERNO	1310
PICKUP	1995	1997	A-393-1051X	CRUCETA SEGURO INTERNO	1310
TITAN	2004	2016	A-153X	CRUCETA SEGURO EXTERNO	1310
TITAN	2007	2015	A-160X	CRUCETA SEGURO EXTERNO	1410
TITAN	2004	2006	A-178X	CRUCETA SEGURO EXTERNO	1350
TITAN	2004	2015	A-200X	CRUCETA SEGURO EXTERNO	1280
TITAN	2004	2015	A-252X	CRUCETA SEGURO EXTERNO	1310
TITAN XD	2016	2016	A-213X	CRUCETA SEGURO EXTERNO	1330
TITAN XD	2016	2016	A-213X	CRUCETA SEGURO EXTERNO	1330
URVAN 2.4L	2001	2012	A-501X	CRUCETA SEGURO INTERNO	NISSAN
URVAN 2.5L DIESEL	2008	2012	A-511X	CRUCETA SEGURO INTERNO	NISSAN
URVAN 3.0L	2008	2012	A-511X	CRUCETA SEGURO INTERNO	NISSAN
XTERRA	2005	2015	A-153X	CRUCETA SEGURO EXTERNO	1310
XTERRA	2005	2015	A-200X	CRUCETA SEGURO EXTERNO	1280
XTERRA	2005	2015	A-213X	CRUCETA SEGURO EXTERNO	1330
XTERRA	2005	2015	A-252X	CRUCETA SEGURO EXTERNO	1310
OLDSMOBILE					
98	1968	1996	A-213X	CRUCETA SEGURO EXTERNO	1330



ARMADORA/MODELO	AÑO INICIAL NOV 2008	AÑO FINAL ENE 2021	NO. DE PARTE Autopar	TIPO DE CRUCETA 	SERIE
-----------------	----------------------------	--------------------------	--------------------------------	--	-------

OLDSMOBILE

442	1968	1970	A-213X	CRUCETA SEGURO EXTERNO	1330
BRAVADA	2000	2004	A-445-1006X	CRUCETA SEGURO INTERNO	1310
BRAVADA	1996	1999	A-534G-1014X	CRUCETA SEGURO INTERNO	1344
BRAVADA	1991	2004	A-534G-1014X	CRUCETA SEGURO INTERNO	1344
CUSTOM CRUISER	1982	1984	A-178X	CRUCETA SEGURO EXTERNO	1350
CUSTOM CRUISER	1971	1992	A-534G-1014X	CRUCETA SEGURO INTERNO	1344
CUTLASS	1964	1998	A-178X	CRUCETA SEGURO EXTERNO	1350
CUTLASS	1968	1970	A-213X	CRUCETA SEGURO EXTERNO	1330
CUTLASS	1961	1998	A-534G-1014X	CRUCETA SEGURO INTERNO	1344
CUTLASS CALAIS	1982	1984	A-178X	CRUCETA SEGURO EXTERNO	1350
CUTLASS CALAIS	1978	1984	A-534G-1014X	CRUCETA SEGURO INTERNO	1344
CUTLASS CRUISER	1982	1983	A-178X	CRUCETA SEGURO EXTERNO	1350
CUTLASS CRUISER	1980	1983	A-534G-1014X	CRUCETA SEGURO INTERNO	1344
CUTLASS SALON	1985	1987	A-178X	CRUCETA SEGURO EXTERNO	1350
CUTLASS SALON	1975	1987	A-534G-1014X	CRUCETA SEGURO INTERNO	1344
CUTLASS SUPREME	1982	1996	A-178X	CRUCETA SEGURO EXTERNO	1350
CUTLASS SUPREME	1967	1988	A-534G-1014X	CRUCETA SEGURO INTERNO	1344
DELMONT 88	1968	1968	A-213X	CRUCETA SEGURO EXTERNO	1330
DELTA 88	1968	1996	A-213X	CRUCETA SEGURO EXTERNO	1330
DELTA 88	1965	1985	A-534G-1014X	CRUCETA SEGURO INTERNO	1344
F85	1970	1970	A-213X	CRUCETA SEGURO EXTERNO	1330
JETSTAR 88	1965	1965	A-213X	CRUCETA SEGURO EXTERNO	1330
STARFIRE	1965	1965	A-213X	CRUCETA SEGURO EXTERNO	1330
VISTA CRUISER	1968	1970	A-213X	CRUCETA SEGURO EXTERNO	1330

PLYMOUTH

BARRACUDA	1964	1974	A-1306X	CRUCETA SEGURO INTERNO	7260
BELVEDERE	1966	1967	A-213X	CRUCETA SEGURO EXTERNO	1330
CARAVELLE	1984	1989	A-1306X	CRUCETA SEGURO INTERNO	7260
CRICKET	1971	1974	A-341-1027X	CRUCETA SEGURO EXTERNO	1210
FURY	1966	1967	A-213X	CRUCETA SEGURO EXTERNO	1330
FURY	1958	1978	A-1306X	CRUCETA SEGURO INTERNO	7260
GRAN FURY	1972	1989	A-1306X	CRUCETA SEGURO INTERNO	7260
GRAND VOYAGER	1989	1990	A-1306X	CRUCETA SEGURO INTERNO	7260
GTX	1967	1967	A-213X	CRUCETA SEGURO EXTERNO	1330
GTX	1968	1971	A-1306X	CRUCETA SEGURO INTERNO	7260
SATELLITE	1966	1967	A-213X	CRUCETA SEGURO EXTERNO	1330

PONTIAC

6000	1989	1990	A-437G-1741X	CRUCETA SEGURO EXTERNO	1210
BONNEVILLE	1982	1984	A-178X	CRUCETA SEGURO EXTERNO	1350
CATALINA	1956	1981	A-534G-1014X	CRUCETA SEGURO INTERNO	1344
EXECUTIVE	1967	1970	A-534G-1014X	CRUCETA SEGURO INTERNO	1344
FIREBIRD	1982	1984	A-178X	CRUCETA SEGURO EXTERNO	1350
FIREBIRD	1988	1993	A-534G-1014X	CRUCETA SEGURO INTERNO	1344
FIREBIRD	1967	2002	A-534G-1014X	CRUCETA SEGURO INTERNO	1344
FIREBIRD	1967	1968	A-621X	CRUCETA SEGURO INTERNO/EXTERNO	1330 - S44
GRAND AM	1973	1980	A-534G-1014X	CRUCETA SEGURO INTERNO	1344
GRAND LEMANS	1975	1983	A-534G-1014X	CRUCETA SEGURO INTERNO	1344
GRAND PRIX	1982	1984	A-178X	CRUCETA SEGURO EXTERNO	1350

ARMADORA/MODELO	AÑO INICIAL NOV 2008	AÑO FINAL ENE 2021	NO. DE PARTE Autopar®	TIPO DE CRUCETA 	SERIE
-----------------	----------------------------	--------------------------	---------------------------------	--	-------

PONTIAC					
GTO	1964	1973	A-534G-1014X	CRUCETA SEGURO INTERNO	1344
PARISIENNE	1982	1984	A-178X	CRUCETA SEGURO EXTERNO	1350
SUNBIRD	1976	1980	A-200X	CRUCETA SEGURO EXTERNO	1280
VENTURA	1971	1977	A-200X	CRUCETA SEGURO EXTERNO	1280

RAM					
RAM 1500	2011	2016	A-178X	CRUCETA SEGURO EXTERNO	1350
RAM 1500	2011	2012	A-213X	CRUCETA SEGURO EXTERNO	1330
RAM 1500	2011	2013	A-213X	CRUCETA SEGURO EXTERNO	1330
RAM 2500	2013	2016	A-155X	CRUCETA SEGURO EXTERNO	1550
RAM 2500	2013	2016	A-160X	CRUCETA SEGURO EXTERNO	1410
RAM 2500	2011	2012	A-178X	CRUCETA SEGURO EXTERNO	1350
RAM 3500	2013	2016	A-155X	CRUCETA SEGURO EXTERNO	1550
RAM 3500	2013	2016	A-160X	CRUCETA SEGURO EXTERNO	1410
RAM 3500	2011	2012	A-178X	CRUCETA SEGURO EXTERNO	1350
RAM 3500/4000/4500	2004	2012	ASPL55X	CRUCETA TIPO SPL	WORKER
RAM 4500	2011	2016	A-155X	CRUCETA SEGURO EXTERNO	1550
RAM 4500	2013	2016	A-160X	CRUCETA SEGURO EXTERNO	1410
RAM 4500	2011	2012	A-178X	CRUCETA SEGURO EXTERNO	1350
RAM 5500	2011	2016	A-155X	CRUCETA SEGURO EXTERNO	1550
RAM 5500	2013	2016	A-160X	CRUCETA SEGURO EXTERNO	1410
RAM 5500	2011	2012	A-178X	CRUCETA SEGURO EXTERNO	1350
RAM 5500	2008	2010	ASPL55X	CRUCETA TIPO SPL	WORKER
RAM DAKOTA	2011	2011	A-200X	CRUCETA SEGURO EXTERNO	1280
RAM DAKOTA	2011	2011	A-213X	CRUCETA SEGURO EXTERNO	1330

ROVER					
ROVER 2000	1968	1973	A-344-1021X	CRUCETA SEGURO EXTERNO	1310
ROVER 3500	1972	1980	A-344-1021X	CRUCETA SEGURO EXTERNO	1310
ROVER 3500S	1969	1974	A-344-1021X	CRUCETA SEGURO EXTERNO	1310

SAAB					
9-7X	2008	2009	A-178X	CRUCETA SEGURO EXTERNO	1350
9-7X	2008	2009	A-445-1006X	CRUCETA SEGURO INTERNO	1310
9-7X	2006	2007	A-534G-1014X	CRUCETA SEGURO INTERNO	1344

SUBARU					
BRAT	1978	1987	A-391-1052X	CRUCETA SEGURO INTERNO	NISSAN

SUZUKI					
EQUATOR	2009	2011	A-213X	CRUCETA SEGURO EXTERNO	1330
GRAND VITARA	2000	2005	A-398-1057X	CRUCETA SEGURO EXTERNO	1110
GRAND VITARA	1999	2005	A-398-1057X	CRUCETA SEGURO EXTERNO	1110
SAMURAI	1985	1995	A-398-1057X	CRUCETA SEGURO EXTERNO	1110
SAMURAI	1985	1995	A-398-1057X	CRUCETA SEGURO EXTERNO	1110
SAMURAI	1985	1995	A-398-1057X	CRUCETA SEGURO EXTERNO	1110
SIDEKICK	1989	1998	A-398-1057X	CRUCETA SEGURO EXTERNO	1110
SIDEKICK	1989	1998	A-398-1057X	CRUCETA SEGURO EXTERNO	1110

ARMADORA/MODELO	AÑO INICIAL NOV 2008	AÑO FINAL ENE 2021	NO. DE PARTE Autopar®	TIPO DE CRUCETA 	SERIE
-----------------	----------------------------	--------------------------	---------------------------------	--	-------

TRIUMPH

TR4	1961	1965	A-344-1021X	CRUCETA SEGURO EXTERNO	1310
TR6	1969	1976	A-344-1021X	CRUCETA SEGURO EXTERNO	1310
TR7	1975	1981	A-341-1027X	CRUCETA SEGURO EXTERNO	1210
TR8	1980	1981	A-341-1027X	CRUCETA SEGURO EXTERNO	1210

VOLVO

122	1960	1968	A-341-1027X	CRUCETA SEGURO EXTERNO	1210
240	1990	1993	A-344-1021X	CRUCETA SEGURO EXTERNO	1310
242	1975	1984	A-341-1027X	CRUCETA SEGURO EXTERNO	1210
242	1975	1984	A-344-1021X	CRUCETA SEGURO EXTERNO	1310
244	1975	1984	A-341-1027X	CRUCETA SEGURO EXTERNO	1210
244	1975	1984	A-344-1021X	CRUCETA SEGURO EXTERNO	1310
244	1985	1989	A-344-1021X	CRUCETA SEGURO EXTERNO	1310
245	1975	1984	A-341-1027X	CRUCETA SEGURO EXTERNO	1210
245	1975	1984	A-344-1021X	CRUCETA SEGURO EXTERNO	1310
245	1985	1989	A-344-1021X	CRUCETA SEGURO EXTERNO	1310
262	1978	1997	A-341-1027X	CRUCETA SEGURO EXTERNO	1210
262	1978	1997	A-344-1021X	CRUCETA SEGURO EXTERNO	1310
264	1976	1982	A-341-1027X	CRUCETA SEGURO EXTERNO	1210
264	1976	1982	A-344-1021X	CRUCETA SEGURO EXTERNO	1310
265	1976	1981	A-341-1027X	CRUCETA SEGURO EXTERNO	1210
265	1976	1981	A-344-1021X	CRUCETA SEGURO EXTERNO	1310
740	1985	1992	A-344-1021X	CRUCETA SEGURO EXTERNO	1310
740	1985	1992	A-344-1021X	CRUCETA SEGURO EXTERNO	1310
760	1983	1990	A-344-1021X	CRUCETA SEGURO EXTERNO	1310
760	1983	1990	A-344-1021X	CRUCETA SEGURO EXTERNO	1310
940	1991	1995	A-344-1021X	CRUCETA SEGURO EXTERNO	1310
960	1992	1994	A-344-1021X	CRUCETA SEGURO EXTERNO	1310

CRUCETAS SEGUROS EXTERNOS



Autopar[®]

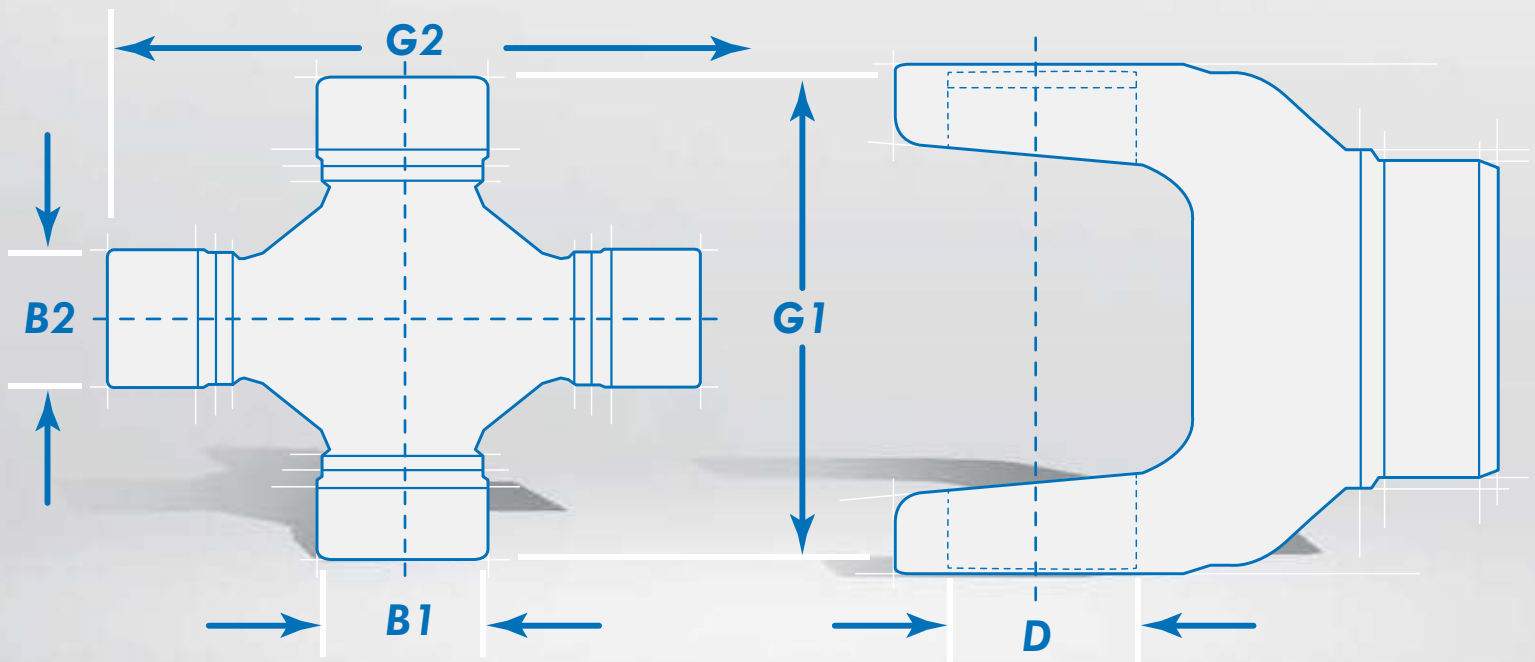

Drive Train



- **Diametro de taza B1**
- **Diametro de taza B2**
- **Distancia entre seguros externos G1**
- **Distancia entre seguros externos G2**

CRUCETAS SEGUROS EXTERNOS



NO. DE PARTE	APLICACIÓN			SERIE	GRASERA
					
A-002X	GM P-30 1991-1996			1350 - 1410	SI
A-008X	GM SUBURBAN EJE NACIONAL			1310 - 1330	SI
A-009X	GM SUBURBAN EJE IMPORTADO			1330	SI
A-153X	NISSAN D21 1994-2008			1310	SI
A-155X	RAM 3500 2013-2016			1550	SI
A-160X	FORD F-250 1999-2016			1410	SI
A-178X	DODGE RAM 1500 2004-2012			1350	SI
A-188X	FORD F-450 SD 1999-2010			1480	SI
A-200X	FORD E100 ECONOLINE 1963-1977			1280	SI
A-213X	CHEVROLET COLORADO 2004-2012			1330	SI
A-252X	FORD RANGER 1990-2011			1310	NO
A-500X	DODGE H100 2.4/2.5L 2002-2014			DODGE	NO
A-502X	NISSAN NP300 D23 15-19			NISSAN	NO
A-505X	ISUZU ELF 400 /450 2007-2015			ISUZU	SI
A-509X	NISSAN CABSTAR 2008-2014			NISSAN	SI
A-513X	ISUZU ELF 200 2009-2017			ISUZU	SI
A-516X	DODGE RAM 2500 2010-2011			DODGE	NO
A-517X	DODGE RAM 3500/4000 2010-2012			DODGE	NO
A-522X	NUDO DE DIRECCION MERCEDES BENZ			1000	NO
A-341-1027X	CHEVROLET LUV 1975-1982			1210	SI
A-344-1021X	VOLVO 240 1990-1993			1310	SI
A-353-1034X	LINCOLN CONTINENTAL 1961-1962			1310 - 1330	SI
A-398-1057X	CHEVROLET TRACKER 1989-2004			1110	SI
A-437G-1741X	AMC GREMLIN 1975			1210	SI
A-880-1780X	ROCKWELL L14N			1240	SI
A-964-1781X	ROCKWELL 35N			1340	SI
ASPL55X	WORKER 8-150E 2007-2009			WORKER	SI
ASPL90X	FORD F-650 SD 1999-2002			SPL90	SI
A-900X	FREIGHTLINER 360 2007			360	SI
A-903X	NISSAN VERSA MARCH TIIDA, HONDA CITY CIVIC			DIRECCIÓN	NO

DIÁMETRO DE TAZAS B1



PULGADAS | MILÍMETROS

DIÁMETRO DE TAZAS B2



PULGADAS | MILÍMETROS

DIST. ENTRE SEGUROS EXTERNOS G1



PULGADAS | MILÍMETROS

DIST. ENTRE SEGUROS EXTERNOS G2



PULGADAS | MILÍMETROS

DIÁMETRO DE TAZAS B1		DIÁMETRO DE TAZAS B2		DIST. ENTRE SEGUROS EXTERNOS G1		DIST. ENTRE SEGUROS EXTERNOS G2	
PULGADAS	MILÍMETROS	PULGADAS	MILÍMETROS	PULGADAS	MILÍMETROS	PULGADAS	MILÍMETROS
1.188	30.175	1.188	30.175	3.625	92.075	4.188	106.375
1.063	27.000	1.063	27.000	3.218	81.737	3.622	91.999
1.063	27.000	1.063	27.000	3.625	92.075	3.625	92.075
1.062	26.975	1.062	26.975	3.219	81.763	3.219	81.763
1.375	34.925	1.375	34.925	4.964	126.086	4.964	126.086
1.188	30.175	1.188	30.175	4.188	106.375	4.188	106.375
1.188	30.175	1.188	30.175	3.622	91.999	3.622	91.999
1.375	34.925	1.375	34.925	4.188	106.375	4.188	106.375
1.063	26.988	1.063	26.988	3.218	81.737	3.218	81.737
1.062	26.975	1.062	26.975	3.625	92.075	3.625	92.075
1.063	27.000	1.063	27.000	3.219	81.763	3.219	81.763
1.062	26.975	1.062	26.975	3.150	80.010	3.150	80.010
1.062	26.975	1.062	26.975	3.644	92.558	3.644	92.558
1.379	35.027	1.379	35.027	4.140	105.156	4.140	105.156
1.060	26.924	1.060	26.924	2.950	74.930	2.950	74.930
1.297	32.944	1.297	32.944	4.060	103.124	4.060	103.124
1.188	30.175	1.188	30.175	3.645	92.583	3.645	92.583
1.374	34.900	1.374	34.900	4.244	107.798	4.244	107.798
0.750	19.050	0.750	19.050	1.895	48.133	1.895	48.133
0.936	23.774	0.936	23.774	2.409	61.189	2.409	61.189
1.063	27.000	1.063	27.000	2.935	74.549	2.935	74.549
1.063	27.000	1.063	27.000	3.626	92.100	3.216	81.686
0.984	24.994	0.984	24.994	2.513	63.830	2.513	63.830
1.062	26.975	1.062	26.975	2.438	61.925	2.438	61.925
1.125	28.575	1.125	28.575	2.622	66.599	2.622	66.599
1.250	31.750	1.250	31.750	3.204	81.382	3.204	81.382
1.370	34.798	1.370	34.798	4.190	106.426	4.190	106.426
1.625	41.275	1.625	41.275	4.960	125.984	4.960	125.984
1.251	31.770	1.251	31.770	4.016	102.000	4.016	102.000
0.591	15.000	0.591	15.000	1.575	40.000	1.575	40.000

CRUCETAS SEGUROS INTERNOS



Autopar[®]

Drive Train

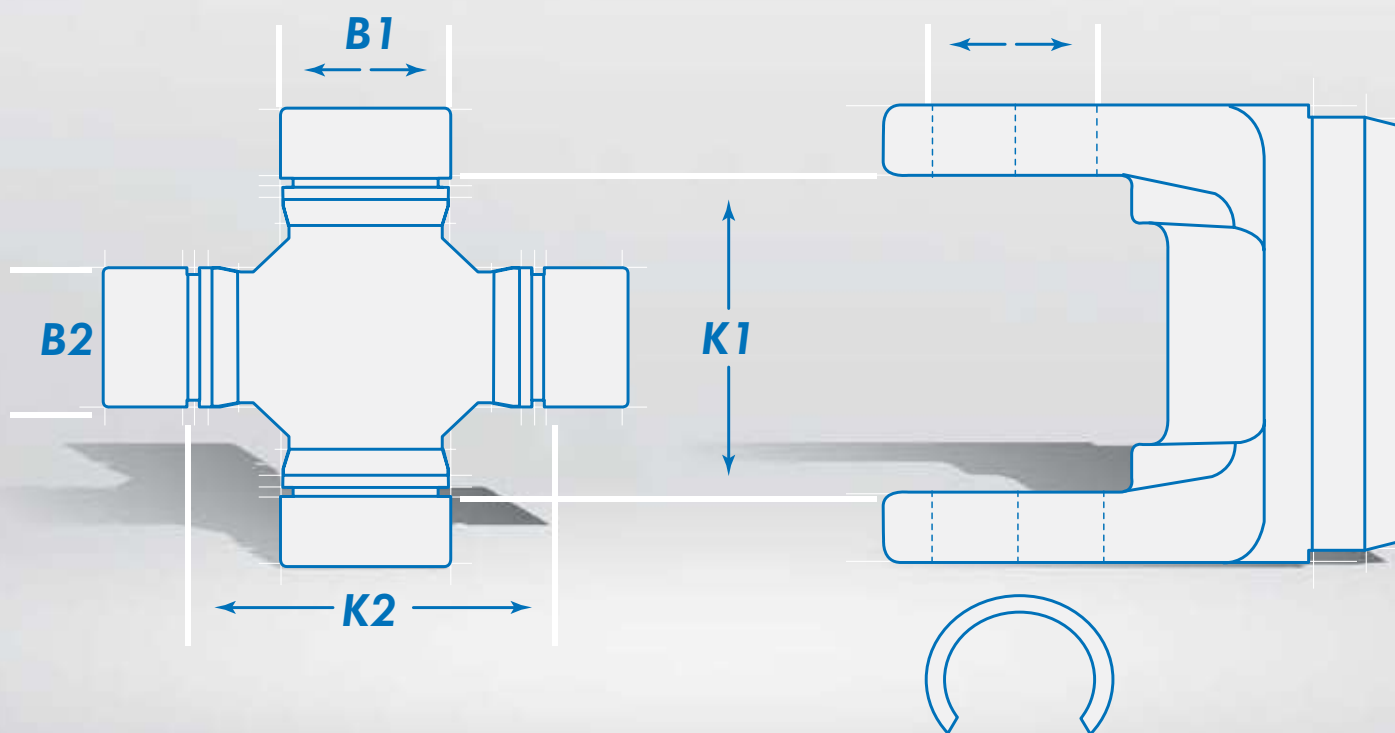

- **Diametro de taza B1**
- **Diametro de taza B2**
- **Distancia entre seguros internos K1**
- **Distancia entre seguros internos K2**

CRUCETAS SEGUROS INTERNOS



NO. DE PARTE	APLICACIÓN			SERIE	GRASERA
					
A-1306X	DODGE CARAVAN 1989-1990			7260	SI
A-170X	FREIGHTLINER			1000	SI
A-501X	NISSAN URVAN 2.4L 2000-2012			NISSAN	NO
A-503X	TOYOTA AVANZA 2007-2017			TOYOTA	NO
A-504X	TOYOTA HIACE 2006-2018			TOYOTA	NO
A-506X	CHEVROLET LUV 1998-2005			GMC	NO
A-511X	NISSAN URVAN 3.0L/2.5L. DIESEL 2008-2012			NISSAN	NO
A-519X	NISSAN NV350 2013-2017			NISSAN	SI
A-526X	MITSUBISHI L200 2008-2015			MITSUBISHI	SI
A-384-1029X	MAZDA B2200 1987-1993			1310	SI
A-387-1017X	TOYOTA FJ CRUISER 2007-2014			TOYOTA	NO
A-391-1052X	NISSAN D21 4X4 1988-1989			NISSAN	SI
A-393-1051X	NISSAN PATHFINDER 2001-2004			1310	SI
A-429-1010X	FORD RANCHERO 1960-1974			1310	SI
A-433-1012X	FORD GALAXIE 1963-1965			P55	SI
A-445-1006X	HUMMER H3 2006-2010			1310	SI
A-534G-1014X	CHEVROLET AVALANCHE 1500 2002-2006			1344	SI
ASPL55-3X	CHRYSLER D600 1974-1980			SPL55	NO

DIÁMETRO DE TAZAS B1



PULGADAS | MILÍMETROS

DIÁMETRO DE TAZAS B2



PULGADAS | MILÍMETROS

DIST. ENTRE SEGUROS INTERNOS K1



PULGADAS | MILÍMETROS

DIST. ENTRE SEGUROS INTERNOS K2



PULGADAS | MILÍMETROS

REFERENCIA SIN SEGURO



PULGADAS

DIÁMETRO DE TAZAS B1		DIÁMETRO DE TAZAS B2		DIST. ENTRE SEGUROS INTERNOS K1		DIST. ENTRE SEGUROS INTERNOS K2		REFERENCIA SIN SEGURO
PULGADAS	MILÍMETROS	PULGADAS	MILÍMETROS	PULGADAS	MILÍMETROS	PULGADAS	MILÍMETROS	PULGADAS
1.078	27.381	1.078	27.381	2.125	53.975	2.125	53.975	1.996
0.938	23.825	0.938	23.825	1.500	38.100	1.500	38.100	1.370
1.062	26.975	1.062	26.975	2.014	51.151	2.014	51.151	1.812
1.142	29.007	1.142	29.007	1.968	49.987	1.968	49.987	1.956
1.143	29.032	1.143	29.032	2.096	53.238	2.096	53.238	1.921
1.142	29.007	1.142	29.007	1.968	49.987	1.968	49.987	
1.102	27.991	1.102	27.991	2.187	55.549	2.187	55.549	2.061
1.260	32.004	1.260	32.004	2.354	59.792	2.354	59.792	2.167
1.181	29.997	1.181	29.997	2.980	75.692	2.980	75.692	2.805
1.103	28.016	1.103	28.016	2.323	59.004	2.323	59.004	2.201
1.140	28.956	1.140	28.956	2.047	51.994	2.047	51.994	1.926
0.983	24.968	0.983	24.968	1.732	43.993	1.732	43.993	1.570
1.103	28.016	1.103	28.016	2.205	56.007	2.205	56.007	2.086
1.064	27.026	1.064	27.026	2.375	60.325	2.375	60.325	
1.062	26.975	1.062	26.975	2.781	70.637	2.781	70.637	2.663
1.061	26.949	1.061	26.949	2.343	59.512	2.343	59.512	
1.125	28.575	1.125	28.575	2.563	65.100	2.563	65.100	2.367
1.375	34.925	1.375	34.925	3.000	76.200	3.000	76.200	2.871

CRUCETAS SEGUROS MIXTOS



CRUCETAS DE PLACAS



Autopar[®]

Drive Train

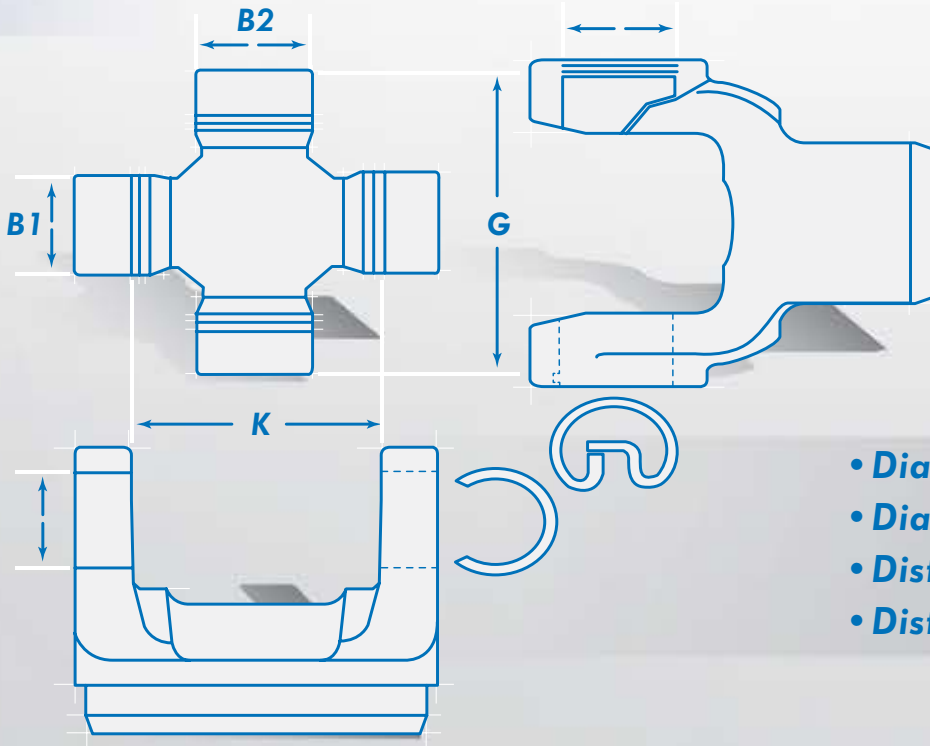

- *Diametro de taza B1*
- *Diametro de taza B2*
- *Distancia entre seguros externos G*
- *Distancia entre seguros internos K*

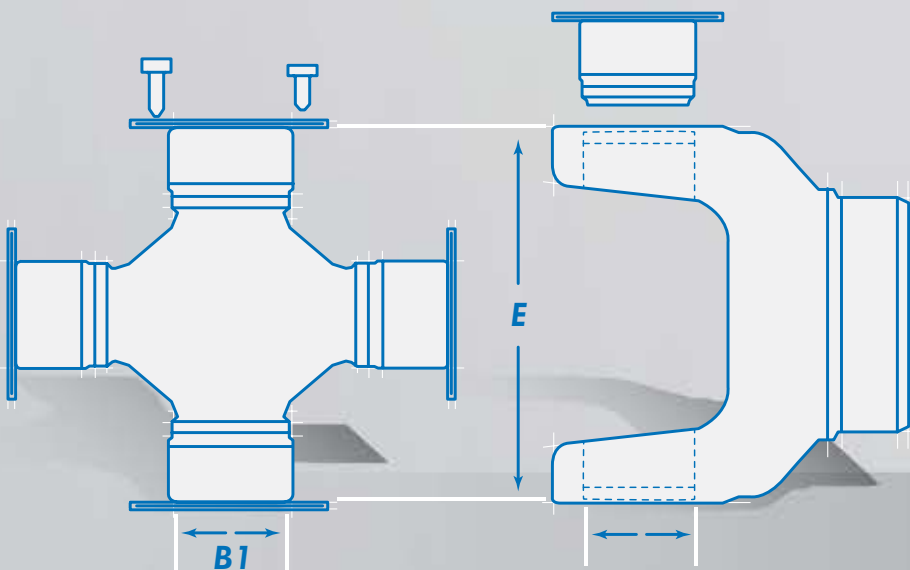





- *Diametro de la taza B1*
- *Distancia entre placas E*

CRUCETAS SEGUROS MIXTOS



NO. DE PARTE	APLICACIÓN   	SERIE 	GRASERA 
A-360X	RAM CHARGER 1987-1996	1310-7260	SI
A-621X	CHEVROLET COLORADO 2004-2006	1330 - S44	NO
A-637X	DODGE DURANGO 1998-1999	1330 - 7290	NO

CRUCETAS DE PLACAS

NO. DE PARTE	APLICACIÓN  	SERIE 	GRASERA 
A-279X	FORD, CHEVROLET, FREIGHTLINER, INTERNATIONAL, NAVISTAR, 1610 SI KENWORTH, MACK, PETERBILT, STERLING, VOLVO 1998-2010	1610	SI
A-280X	FORD, CHEVROLET, FREIGHTLINER, INTERNATIONAL, NAVISTAR, 1610 SI KENWORTH, MACK, PETERBILT, STERLING, VOLVO 1998-2010	1710	SI
A-281X	FORD, CHEVROLET, FREIGHTLINER, INTERNATIONAL, NAVISTAR, 1610 SI KENWORTH, MACK, PETERBILT, STERLING, VOLVO 1998-2010	1810	SI
A-407X	FORD, CHEVROLET, FREIGHTLINER, INTERNATIONAL, NAVISTAR, 1610 SI KENWORTH, MACK, PETERBILT, STERLING, VOLVO 1998-2010	1760	SI

DIÁMETRO DE TAZAS B1



PULGADAS | MILÍMETROS

DIÁMETRO DE TAZAS CON RANURA B2



PULGADAS | MILÍMETROS

DIST. ENTRE SEGUROS EXTERNOS G



PULGADAS | MILÍMETROS

DIST. ENTRE SEGUROS INTERNOS K



PULGADAS | MILÍMETROS

REFERENCIA SIN SEGURO



PULGADAS

DIÁMETRO DE TAZAS B1		DIÁMETRO DE TAZAS CON RANURA B2		DIST. ENTRE SEGUROS EXTERNOS G		DIST. ENTRE SEGUROS INTERNOS K		REFERENCIA SIN SEGURO
PULGADAS	MILÍMETROS	PULGADAS	MILÍMETROS	PULGADAS	MILÍMETROS	PULGADAS	MILÍMETROS	PULGADAS
1.061	26.949	1.076	27.330	3.210	81.534	2.125	53.975	2.000
1.063	27.000	1.125	28.575	3.625	92.075	2.556	64.922	2.458
1.063	27.000	1.125	28.575	3.625	92.075	2.625	66.675	2.502

CRUCETAS DE PLACAS

DIÁMETRO DE TAZAS B1



PULGADAS | MILÍMETROS

DISTANCIA ENTRE PLACAS E



PULGADAS | MILÍMETROS

DISTANCIA ENTRE CENTROS DE BARRENOS DE TAPAS



PULGADAS | MILÍMETROS

DIÁMETRO DE TAZAS B1		DISTANCIA ENTRE PLACAS E		DISTANCIA ENTRE CENTROS DE BARRENOS DE TAPAS	
PULGADAS	MILÍMETROS	PULGADAS	MILÍMETROS	PULGADAS	MILÍMETROS
1.875	47.625	5.312	134.925	2.308	58.623
1.938	49.225	6.094	154.788	2.437	61.900
1.938	49.225	7.547	191.694	2.437	61.900
1.938	49.225	7.000	177.800	2.437	61.900

CRUCETA DE SEGUROS EXTERNOS-PLACAS



CRUCETA DE SEGUROS EXTERNOS-RIEL



CRUCETA DE RIEL



CRUCETA DE SPL



Autopar[®]

Drive Train

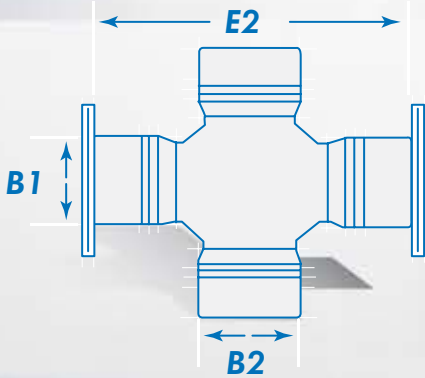

- *Diametro de taza 1 - B1*
- *Diametro de taza 2 - B2*
- *Distancia entre seguros externos - E1*
- *Distancia entre placas - E2*

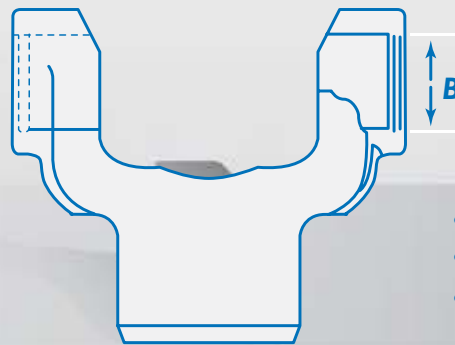
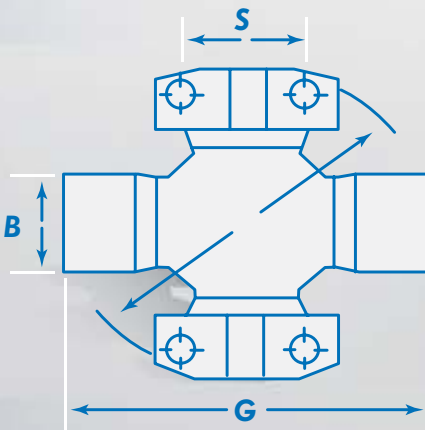

- *Diametro de taza B*
- *Diametro entre centro de barrenos S*
- *Distancia entre seguros internos G*

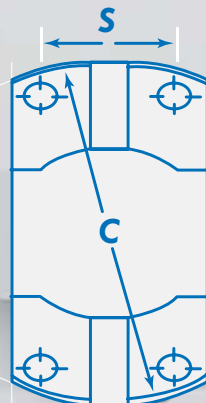
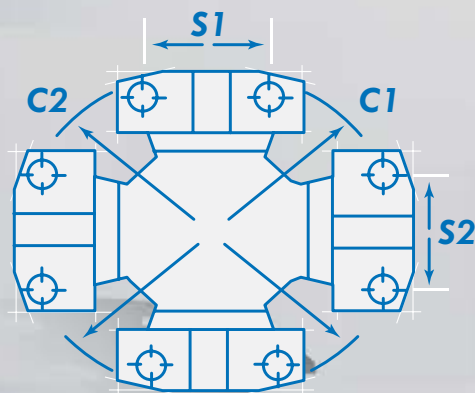

- *Diametro entre centro de barreno - S1*
- *Diametro entre centro de barreno - S2*
- *Diametro piloto C1*
- *Diametro piloto C2*

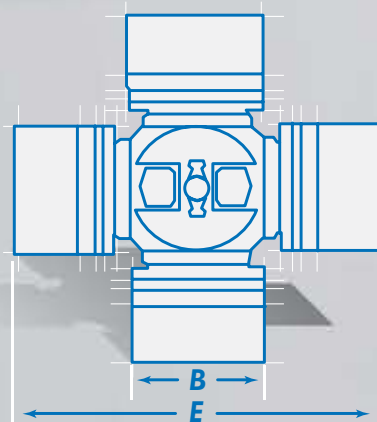

- *Diametro de taza B*
- *Span E*

CRUCETAS DE SEGUROS EXTERNOS-PLACAS



NO. DE PARTE	APLICACIÓN	SERIE	GRASERA
A-438X	VOLVO	1610	NO
A-674X	KENWORTH	1610	SI
A-675X	FREIGHTLINER	1710	SI
A-677X	FREIGHTLINER	1760	SI
A-676X	MACK	1810	SI

CRUCETAS DE SEGUROS EXTERNOS-RIEL

NO. DE PARTE	APLICACIÓN	SERIE	GRASERA
A20RPL	FREIGHTLINER COLUMBIA 2004-2012	RPL20	NO
A25RPL	FREIGHTLINER COLUMBIA 2004-2012	RPL25	NO

CRUCETA DE RIEL

NO. DE PARTE	APLICACIÓN	SERIE	GRASERA
A-5177X	EQUIPO INDUSTRIAL ITALCARDANO	5C	SI
A-6000X	EQUIPO INDUSTRIAL ROCKWELL 62N	6C	SI
A-7000X	EQUIPO INDUSTRIAL ROCKWELL 72N	7C/72N	SI
A-7111X	EJE ITALCARDANO 7C/72N	7C/72N	SI
A-7115X	EJE ROCKWELL MECHANICS 7C/72N	7C/72N	SI
A-9111X	EJE ITALCARDANO 9C/92N	9C/92N	SI

CRUCETA TIPO SPL

NO. DE PARTE	APLICACIÓN	SERIE	GRASERA
ASPL140X	FREIGHTLINER, INTERNATIONAL, NAVISTAR, KENWORTH, MACK, PETERBILT, STERLING, VOLVO 1998-2017	SPL140	SI
ASPL170X	FREIGHTLINER, INTERNATIONAL, NAVISTAR, KENWORTH, MACK, PETERBILT, STERLING, VOLVO 1998-2017	SPL170	SI
ASPL250X	FREIGHTLINER, INTERNATIONAL, NAVISTAR, KENWORTH, MACK, PETERBILT, STERLING, VOLVO 1998-2017	SPL250	SI

DIÁMETRO DE TAZAS B1



PULGADAS | MILÍMETROS

1.875	47.625
1.875	47.625
1.938	49.225
1.938	49.225
1.938	49.225

DIÁMETRO DE TAZAS B2



PULGADAS | MILÍMETROS

1.875	47.625
1.875	47.625
1.938	49.225
1.938	49.225
1.938	49.225

DIST. ENTRE SEGUROS EXTERNOS E1



PULGADAS | MILÍMETROS

5.312	134.925
5.312	134.925
6.200	157.480
7.108	180.543
7.650	194.310

DISTANCIA ENTRE PLACAS E2



PULGADAS | MILÍMETROS

5.312	134.925
5.312	134.925
6.094	154.788
7.000	177.800
7.547	191.694

CRUCETAS DE SEGUROS EXTERNOS-RIEL

DIÁMETRO DE TAZAS B



PULGADAS | MILÍMETROS

2.061	52.349
2.061	52.349

DISTANCIA ENTRE CENTRO DE BARRENOS S



PULGADAS | MILÍMETROS

2.81	71.374
2.81	71.374

DISTANCIA ENTRE SEGUROS EXTERNOS G



PULGADAS | MILÍMETROS

6.994	177.6476
8.219	208.7626

CRUCETA DE RIEL

DISTANCIA ENTRE CENTROS DE BARRENOS S1



PULGADAS | MILÍMETROS

1.687	42.850
1.686	42.824
1.938	49.225
1.938	49.225
1.938	49.225
2.812	71.424

DISTANCIA ENTRE CENTROS DE BARRENOS S2



PULGADAS | MILÍMETROS

1.687	42.85
1.686	42.824
1.938	49.225
1.938	49.225
1.938	49.225
2.812	71.424

DIAMETRO PILOTO C1



PULGADAS | MILÍMETROS

4.531	115.087
5.531	140.487
5.844	148.412
5.844	148.437
5.844	148.437
8.250	209.55

DIAMETRO PILOTO C2



PULGADAS | MILÍMETROS

4.531	115.087
5.531	140.487
5.844	148.412
5.844	148.437
5.844	148.437
8.250	209.55

TIPO DE ALA



HWD (SIN CUERDA)
LWT (CON CUERDA)
LWT (CON CUERDA)
HWD (SIN CUERDA)
HWD/LWT (SIN/CON CUERDA)
HWD (SIN CUERDA)

CRUCETA TIPO SPL

DIÁMETRO DE TAZAS B



PULGADAS | MILÍMETROS

1.937	49.200
2.165	54.991
2.362	59.995

SPAN E



PULGADAS | MILÍMETROS

5.461	138.709
6.456	163.982
6.417	162.992

Autopar[®]

Drive Train

ABRAZADERAS



NO. DE PARTE	APLICACIÓN DE CRUCETA	DIÁMETRO DE TAZA		LONGITUD CENTRO A CENTRO		DESCRIPCIÓN	SERIE	TORQUE TORNILLOS	
		PULGADAS	MILIMETROS	PULGADAS	MILIMETROS			Lb-ft	Nm
A2-70-18X	A-200X A-153X A-252X A-008X A-213X	1.062	26.975	1.587	40.31	2 ABRAZADERAS Y 4 TORNILLOS	1210 1310 1330	13-18	17.62-24.40
A3-70-28X	A-160X A-178X A-516X	1.188	30.175	1.806	45.872	2 ABRAZADERAS Y 4 TORNILLOS	1350 1410	25 - 30	33.9 - 40.68
A3-70-38X	A-188X A-155X	1.375	34.925	2.13	54.102	2 ABRAZADERAS Y 4 TORNILLOS	1480 1550	55 - 60	74.58 - 81.36
A5-70-28X	A-674X A-438X	1.875	47.625	2.5	63.5	2 ABRAZADERAS Y 4 TORNILLOS	1610	45 - 60	61.02 - 81.36
A6.5-70-18X	A-675X A-677X A-676X	1.938	49.225	2.806	71.272	2 ABRAZADERAS Y 4 TORNILLOS	1710 1760 1810	115 -135	155.94-183.06
A250-70-18X	ASPL250X	2.362	59.995	3.444	87.478	2 ABRAZADERAS Y 4 TORNILLOS	SPL250	115 - 135	155.91-183.03

CONSECUTIVO CON IMAGEN



Autopar[®]

Drive Train



CONSECUTIVO CON IMAGEN



NO. DE PARTE	IMAGEN	NO. DE PARTE	IMAGEN
A-002X		A-008X	
A-009X		A-1306X	
A-153X		A-155X	
A-160X		A-170X	
A-178X		A-188X	

NO. DE PARTE

IMAGEN



NO. DE PARTE

IMAGEN



A-200X



A-213X



A-252X



A-279X



A-280X



A-281X



A-360X

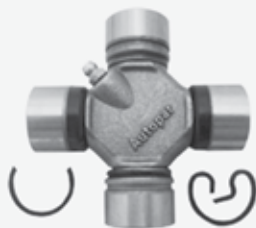

A-407X



A-438X



A-500X



CONSECUTIVO CON IMAGEN



NO. DE PARTE	IMAGEN	NO. DE PARTE	IMAGEN
A-502X		A-503X	
A-504X		A-505X	
A-506X		A-509X	
A-511X		A-513X	
A-517X		A-519X	

NO. DE PARTE

IMAGEN



NO. DE PARTE

IMAGEN



A-522X



A-526X



A-621X



A-637X



A-674X



A-675X



A-676X



A-677X



A-7000X















A-7111X



CONSECUTIVO CON IMAGEN



NO. DE PARTE	IMAGEN 	NO. DE PARTE	IMAGEN 
A-7115X		A-900X	
A-903X		A-9111X	
ASPL140X		ASPL170X	
ASPL250X		ASPL55-3X	
ASPL55X		ASPL90X	

NO. DE PARTE

IMAGEN



NO. DE PARTE

IMAGEN



A20RPL



A25RPL



A-341-1027X



A-344-1021X



A-353-1034X



A-384-1029X



A-387-1017X



A-391-1052X



A-393-1051X











A-398-1057X



CONSECUTIVO CON IMAGEN



NO. DE PARTE	IMAGEN 	NO. DE PARTE	IMAGEN 
A-429-1010X		A-433-1012X	
A-437G-1741X		A-445-1006X	
A-534G-1014X		A-880-1780X	
A-964-1781X			

Lined area for notes, consisting of multiple horizontal lines.

GUÍA RÁPIDA





Autopar[®]

Drive Train





CRUCETA SEGURO EXTERNO

NO. DE PARTE	APLICACIÓN   	DIST. ENTRE SEGUROS EXTERNOS G 1	
		PULGADAS	MILÍMETROS
A-903X	NUDO DE DIRECCION VEHICULOS LIGEROS	1.575	40.000
A-522X	NUDO DE DIRECCION MERCEDES BENZ	1.895	48.133
A-341-1027X	CHEVROLET LUV 1975-1982	2.409	61.189
A-437G-1741X	AMC GREMLIN 1975	2.438	61.925
A-398-1057X	CHEVROLET TRACKER 1989-2004	2.513	63.830
A-880-1780X	ROCKWELL L14N	2.622	66.599
A-344-1021X	VOLVO 240 1990-1993	2.935	74.549
A-509X	NISSAN CABSTAR 2008-2014	2.950	74.930
A-500X	DODGE H100 2.4/2.5L 2002-2014	3.150	80.010
A-964-1781X	ROCKWELL 35N	3.204	81.382
A-200X	FORD E100 ECONOLINE 1963-1977	3.218	81.737
A-008X	GM SUBURBAN EJE NACIONAL	3.218	81.737
A-153X	NISSAN D21 1994-2008	3.219	81.763
A-252X	FORD RANGER 1990-2011	3.219	81.763
A-178X	DODGE RAM 1500 2004-2012	3.622	91.999
A-213X	CHEVROLET COLORADO 2004-2012	3.625	92.075
A-009X	GM SUBURBAN EJE IMPORTADO	3.625	92.075
A-002X	GM P-30 1991-1996	3.625	92.075
A-353-1034X	LINCOLN CONTINENTAL 1961-1962	3.626	92.100
A-502X	NISSAN NP300 D23 15-	3.644	92.558
A-516X	DODGE RAM 2500 2010-2011	3.645	92.583
A-900X	FREIGHTLINER 360	4.016	102.000
A-513X	ISUZU ELF 200 2009-2017	4.060	103.124
A-505X	ISUZU ELF 400 /450 2007-2015	4.140	105.156
A-160X	FORD F-250 1999-2016	4.188	106.375
A-188X	FORD F-450 SD 1999-2010	4.188	106.375
ASPL55X	WORKER 8-150E 2007-2009	4.190	106.426
A-517X	DODGE RAM 3500/4000 2010-2012	4.244	107.798
ASPL90X	FORD F-650 SD 1999-2002	4.960	125.984
A-155X	RAM 3500 2013-2016	4.964	126.086

DIÁMETRO DE TAZAS B1

PULGADAS | MILÍMETROS
DIST. ENTRE SEGUROS EXTERNOS G2

PULGADAS | MILÍMETROS
DIÁMETRO DE TAZAS B2





PULGADAS | MILÍMETROS
SERIE

GRASERA

DIÁMETRO DE TAZAS B1		DIST. ENTRE SEGUROS EXTERNOS G2		DIÁMETRO DE TAZAS B2		SERIE	GRASERA
PULGADAS	MILÍMETROS	PULGADAS	MILÍMETROS	PULGADAS	MILÍMETROS		
0.591	15.000	1.575	40.000	0.591	15.000	DIRECCIÓN	NO
0.750	19.050	1.895	48.133	0.750	19.050	1000	NO
0.936	23.774	2.409	61.189	0.936	23.774	1210	SI
1.062	26.975	2.438	61.925	1.062	26.975	1210	SI
0.984	24.994	2.513	63.830	0.984	24.994	1110	SI
1.125	28.575	2.622	66.599	1.125	28.575	1240	SI
1.063	27.000	2.935	74.549	1.063	27.000	1310	SI
1.060	26.924	2.950	74.930	1.060	26.924	NISSAN	SI
1.062	26.975	3.150	80.010	1.062	26.975	DODGE	NO
1.250	31.750	3.204	81.382	1.250	31.750	1340	SI
1.063	26.988	3.218	81.737	1.063	26.988	1280	SI
1.063	27.000	3.622	91.999	1.063	27.000	1310 - 1330	SI
1.062	26.975	3.219	81.763	1.062	26.975	1310	SI
1.063	27.000	3.219	81.763	1.063	27.000	1310	NO
1.188	30.175	3.622	91.999	1.188	30.175	1350	SI
1.062	26.975	3.625	92.075	1.062	26.975	1330	SI
1.063	27.000	3.625	92.075	1.063	27.000	1330	SI
1.188	30.175	4.188	106.375	1.188	30.175	1350 - 1410	SI
1.063	27.000	3.216	81.686	1.063	27.000	1310 - 1330	SI
1.062	26.975	3.644	92.558	1.062	26.975	NISSAN	NO
1.188	30.175	3.645	92.583	1.188	30.175	DODGE	NO
1.251	31.770	4.016	102.000	1.251	31.770	360	SI
1.297	32.944	4.060	103.124	1.297	32.944	ISUZU	SI
1.379	35.027	4.140	105.156	1.379	35.027	ISUZU	SI
1.188	30.175	4.188	106.375	1.188	30.175	1410	SI
1.375	34.925	4.188	106.375	1.375	34.925	1480	SI
1.370	34.798	4.190	106.426	1.370	34.798	WORKER	SI
1.374	34.900	4.244	107.798	1.374	34.900	DODGE	NO
1.625	41.275	4.960	125.984	1.625	41.275	SPL90	SI
1.375	34.925	4.964	126.086	1.375	34.925	1550	SI







CRUCETA SEGURO INTERNO





NO. DE PARTE	APLICACIÓN   	DIST. ENTRE SEGUROS INTERNO K1 	
		PULGADAS	MILÍMETROS
A-170X	FREIGHTLINER	1.500	38.100
A-391-1052X	NISSAN D21 4X4 1988-1989	1.732	43.993
A-506X	CHEVROLET LUV 1998-2005	1.968	49.987
A-503X	TOYOTA AVANZA 2007-2017	1.968	49.987
A-501X	NISSAN URVAN 2.4L 2000-2012	2.014	51.151
A-387-1017X	TOYOTA FJ CRUISER 2007-2014	2.047	51.994
A-511X	NISSAN URVAN 3.0L/2.5L. DIESEL 2008-2012	2.187	55.549
A-504X	TOYOTA HIACE 2006-2018	2.096	53.238
A-1306X	DODGE CARAVAN 1989-1990	2.125	53.975
A-393-1051X	NISSAN PATHFINDER 2001-2004	2.205	56.007
A-384-1029X	MAZDA B2200 1987-1993	2.323	59.004
A-445-1006X	HUMMER H3 2006-2010	2.343	59.512
A-519X	NISSAN NV350 2013-2017	2.354	59.792
A-429-1010X	FORD RANCHERO 1960-1974	2.375	60.325
A-534G-1014X	CHEVROLET AVALANCHE 1500 2002-2006	2.563	65.100
A-433-1012X	FORD GALAXIE 1963-1965	2.781	70.637
A-526X	MITSUBISHI L200 2008-2016	2.980	75.692
ASPL55-3X	CHRYSLER D600 1974-1980	3.000	76.200





CRUCETA SEGURO INTERNO/EXTERNO





NO. DE PARTE	APLICACIÓN   	DIST. ENTRE SEGUROS INTERNO K 	
		PULGADAS	MILÍMETROS
A-360X	RAM CHARGER 1987-1996	2.125	53.975
A-621X	CHEVROLET COLORADO 2004-2006	2.556	64.922
A-637X	DODGE DURANGO 1998-1999	2.625	66.675

CRUCETA CON PLACAS EN LA TAZA

NO. DE PARTE	APLICACIÓN   	DISTANCIA ENTRE PLACAS E 	
		PULGADAS	MILÍMETROS
A-279X	KENWORTH 1998-2010	5.312	134.925
A-280X	NAVISTAR 1998-2010	6.094	154.788
A-407X	FREIGHTLINER 1998-2010	7.000	177.800
A-281X	MACK	7.547	191.694

DIÁMETRO DE TAZAS B1		DIST. ENTRE SEGUROS INTERNOS K2		DIÁMETRO DE TAZAS B2		SERIE	GRASERA
							
PULGADAS	MILÍMETROS	PULGADAS	MILÍMETROS	PULGADAS	MILÍMETROS		
0.938	23.825	1.500	38.100	0.938	23.825	1000	SI
0.983	24.968	1.732	43.993	0.983	24.968	NISSAN	SI
1.142	29.007	1.968	49.987	1.142	29.007	GMC	NO
1.142	29.007	1.968	49.987	1.142	29.007	TOYOTA	NO
1.062	26.975	2.014	51.151	1.062	26.975	NISSAN	NO
1.140	28.956	2.047	51.994	1.140	28.956	TOYOTA	NO
1.102	27.991	2.187	55.549	1.102	27.991	NISSAN	NO
1.143	29.032	2.096	53.238	1.143	29.032	TOYOTA	NO
1.078	27.381	2.125	53.975	1.078	27.381	7260	SI
1.103	28.016	2.205	56.007	1.103	28.016	1310	SI
1.103	28.016	2.323	59.004	1.103	28.016	1310	SI
1.061	26.949	2.343	59.512	1.061	26.949	1310	SI
1.260	32.004	2.354	59.792	1.260	32.004	NISSAN	SI
1.064	27.026	2.375	60.325	1.064	27.026	1310	SI
1.125	28.575	2.563	65.100	1.125	28.575	1344	SI
1.062	26.975	2.781	70.637	1.062	26.975	P55	SI
1.181	29.997	2.980	75.692	1.181	29.997	MITSUBISHI	SI
1.375	34.925	3.000	76.200	1.375	34.925	SPL55	NO

DIÁMETRO DE TAZAS B1		DIST. ENTRE SEGUROS EXTERNOS G		DIÁMETRO DE TAZAS B2		SERIE	GRASERA
							
PULGADAS	MILÍMETROS	PULGADAS	MILÍMETROS	PULGADAS	MILÍMETROS		
1.061	26.949	3.210	81.534	1.076	27.330	1310-7260	SI
1.063	27.000	3.625	92.075	1.125	28.575	1330	NO
1.063	27.000	3.625	92.075	1.125	28.575	1330	NO

DIÁMETRO DE TAZAS B1		DISTANCIA ENTRE CENTROS DE BARRENOS DE TAPAS		SERIE	GRASERA
					
PULGADAS	MILÍMETROS	PULGADAS	MILÍMETROS		
1.875	47.625	2.308	58.623	1610	SI
1.938	49.225	2.437	61.900	1710	SI
1.938	49.225	2.437	61.900	1760	SI
1.938	49.225	2.437	61.900	1810	SI



CRUCETA CON PLACAS EN LA TAZA

NO. DE PARTE	APLICACIÓN 	DIST. ENTRE SEGUROS EXTERNOS E1 	
		PULGADAS	MILÍMETROS
A-438X	VOLVO 1998-2010	5.312	134.925
A-674X	KENWORTH 1998-2010	5.312	134.925
A-675X	FREIGHTLINER 1998-2010	6.200	157.480
A-677X	FREIGHTLINER 1998-2010	7.108	180.543
A-676X	MAC1998-2010	7.650	194.310

CRUCETA CON SEGURO EXTERNO/PLACAS

NO. DE PARTE	APLICACIÓN 	DIST. SEGUROS EXTERNOS G 	
		PULGADAS	MILÍMETROS
A20RPL	FREIGHTLINER COLUMBIA 2004-2012	6.994	177.6476
A25RPL	MERCEDES BENZ	8.219	208.7626

CRUCETA DE RIEL

NO. DE PARTE	APLICACIÓN 	DIAMETRO PILOTO C1 	
		PULGADAS	MILÍMETROS
A-7000X	EQUIPO INDUSTRIAL	5.844	148.412
A-7111X	EJE ITALCARDANO 7C/72N	5.844	148.437
A-7115X	EJE ROCKWELL MECHANICS 7C/72N	5.844	148.437
A-9111X	EJE ITALCARDANO 9C/92N	8.250	209.55

CRUCETA TIPO SPL PESADO

NO. DE PARTE	APLICACIÓN 	SPAN E 	
		PULGADAS	MILÍMETROS
ASPL140X	MACK 1998-2017	5.461	138.709
ASPL170X	KENWORTH 1998-2017	6.456	163.982
ASPL250X	KENWORTH 1998-2017	6.417	162.992

DIÁMETRO DE TAZAS B1



PULGADAS | MILÍMETROS

1.875	47.625
1.875	47.625
1.938	49.225
1.938	49.225
1.938	49.225

DIST. PLACAS E2



PULGADAS | MILÍMETROS

5.312	134.925
5.312	134.925
6.094	154.788
7.000	177.800
7.547	191.694

DIÁMETRO DE TAZAS B2



PULGADAS | MILÍMETROS

1.875	47.625
1.875	47.625
1.938	49.225
1.938	49.225
1.938	49.225

SERIE



1610
1610
1710
1760
1810

GRASERA



NO
SI
SI
SI
SI

DIÁMETRO DE TAZAS B



PULGADAS | MILÍMETROS

2.061	52.349
2.061	52.349

DISTANCIA ENTRE CENTROS DE BARRENOS S



PULGADAS | MILÍMETROS

2.81	71.374
2.81	71.374

SERIE



RPL20
RPL25

GRASERA



NO
NO

DIST. CENTROS BARRENOS S1



PULGADAS | MILÍMETROS

1.938	49.225
1.938	49.225
1.938	49.225
2.812	71.424

DIAMETRO PILOTO C2



PULGADAS | MILÍMETROS

5.844	148.412
5.844	148.437
5.844	148.437
8.250	209.55

DIST. CENTROS BARRENOS S2



PULGADAS | MILÍMETROS

1.938	49.225
1.938	49.225
1.938	49.225
2.812	71.424

SERIE



7C/72N
7C/72N
7C/72N
9C/92N

GRASERA



SI
SI
SI
SI

DIAMETRO TAZAS B



PULGADAS | MILÍMETROS

1.937	49.200
2.165	54.991
2.362	59.995

SERIE



SPL140
SPL170
SPL250

GRASERA



SI
SI
SI

INTERCAMBIOS



GMB	Autopar	NEAPCO	Autopar	NEAPCO	Autopar	PRECISION	Autopar
210-0105	A-534G-1014X	1-0005	A-344-1021X	4-1090	ASPL90X	316	A-316-1020X
210-0134	A-353-1034X	1-0011	A-395-1050X	4-5177	A-5177X	317	A-317-1103X
210-0160	A-160X	1-0012	A-390-1058X	4-6143	A-6000X	319	A-360X
210-0170	A-170X	1-0013	A-394-1053X	5-0280	A-280X	330	A-160X
210-0178	A-178X	1-0027	A-391-1052X	5-7205	A-7000X	331	A-178X
210-0260	A-260X	1-0029	A-393-1051X	6-0020	A20RPL	333	A-279X
210-0350	A-445-1006X	1-0105	A-100X	6-0025	A25RPL	334	A-280X
210-0443	A-437G-1741X	1-0134	A-353-1034X	6-0281	A-281X	338	A-170X
210-0456	A-436-1742X	1-0153	A-153X	6-0407	A-407X	341	A-341-1027X
210-1200	A-429-1010X	1-0153	A-252X	6-0675	A-675X	344	A-344-1021X
210-1201	A-430-1011X	1-0170	A-170X	6-0676	A-676X	348	A-348-1746X
210-1203	A-433-1012X	1-0174	A-260X	6-0677	A-677X	351	A-188X
210-1204	A-434-1013X	1-0200	A-200X	6-1170	ASPL170X	353	A-353-1034X
210-1306	A-1306X	1-0298	A-377-1761X	6-1250	ASPL250X	354	A-213X
210-1309	A-316-1020X	1-0300	A-341-1027X			355	A-621X
210-3009	A-621X	1-0443	A-437G-1741X			358	A-155X
211-0297	A-377-1761X	1-0445	A-445-1006X			365	A-260X
211-1306	A-317-1103X	1-1475	A-861-1777X			369	A-200X
220-0006	A-384-1029X	1-1516	A-399-1016X			369	A-153X
220-0011	A-395-1050X	1-1557	A-398-1057X			372	A-372-1699X
220-0012	A-390-1058X	1-1610	A-384-1029X			376	A-407X
220-0013	A-394-1053X	1-1612	A-387-1017X			377	A-377-1761X
220-0021	A-387-1017X	1-2075	A-880-1780X			381	A-281X
220-0027	A-391-1052X	1-4635	A-430-1011X			384	A-384-1029X
220-0029	A-393-1051X	1-5900	A-429-1010X			387	A-387-1017X
220-0046	A-501X	1-6300	A-317-1103X			390	A-390-1058X
220-0081	A-398-1057X	1-6301	A-1306X			391	A-391-1052X
220-0088	A-399-1016X	2-0053	A-178X				
220-0500	A-341-1027X	2-0054	A-160X				
230-0188	A-188X	2-0355	A-637X				
230-0280	A-280X	2-0456	A-436-1742X				
240-0353	A-360X	2-0621	A-621X				
240-0356	A-372-1699X	2-1175	A-316-1020X				
		2-1203	A-433-1012X				
		2-2275	A-964-1781X				
		2-3011	A-534G-1014X				
		2-4800	A-213X				
		2-4900	A-434-1013X				
		3-0155	A-155X				
		3-0188	A-188X				
		3-3130	A-372-1699X				
		3-3140	A-348-1746X				
		4-0279	A-279X				
		4-0674	A-438X				
		4-0674	A-674X				

Autopar®

PRECISION	Autopar	SPICER	Autopar	SPICER	Autopar	TS	Autopar
393	A-393-1051X	5-1200X	A-429-1010X	5-92X	A-861-1777X	HTS333	A-279X
394	A-394-1053X	5-1201X	A-430-1011X	DT3022	A-372-1699X	HTS334	A-280X
395	A-395-1050X	5-1204X	A-434-1013X	SPL170	ASPL170X	HTS351	A-188X
398	A-398-1057X	5-129X	A-880-1780X	SPL250	ASPL250X	HTS358	A-155X
399	A-399-1016X	5-1306-1X	A-317-1103X	SPL90	ASPL90X	HTS376	A-407X
429	A-429-1010X	5-1306SX	A-1306X	5-3214X	A-344-1021X	HTS381	A-281X
430	A-430-1011X	5-1309X	A-316-1020X			HTS460	ASPL90X
433	A-433-1012X	5-1500X	A-395-1050X			HTS475	A-438X
434	A-434-1013X	5-1501X	A-391-1052X			HTS476	A-675X
436	A-436-1742X	5-1502X	A-394-1053X			HTS477	A-677X
445	A-445-1006X	5-1503X	A-398-1057X	15-153X	A-200X	HTS478	A-676X
446	A-501X	5-1505X	A-393-1051X	15-153X	A-153X	HTS578	ASPL170X
460	ASPL90X	5-1507X	A-384-1029X	15-155X	A-155X	HTS579	SPL250
475	A-438X	5-1508X	A-390-1058X	15-160X	A-160X	HTS861	A-861-1777X
578	ASPL170X	5-1510X	A-387-1017X	15-170X	A-170X	HTS876	A-675X
579	ASPL250X	5-1516X	A-399-1016X	15-178X	A-178X	HTS878	A-676X
861	A-861-1777X	5-153X	A-153X	15-188X	A-188X	HTSCP20	A20RPL
875	A-674X	5-155X	A-155X	15-213X	A-213X	HTSCP25	A25RPL
876	A-675X	5-160X	A-160X	15-260X	A-260X		
877	A-677X	5-170X	A-170X	15-279X	A-279X		
878	A-676X	5-178X	A-178X	15-280X	A-280X		
880	A-880-1780X	5-188X	A-188X	15-281X	A-281X		
964	A-964-1781X	5-203X	A-433-1012X	15-407X	A-407X		
315G	A-1306X	5-213X	A-213X	15-674X	A-438X		
437G	A-437G-1741X	5-243X	A-964-1781X	15-674X	A-674X		
458C	A-637X	5-260X	A-260X	15-675X	A-675X		
534G	A-534G-1014X	5-279X	A-279X	15-676X	A-676X		
		5-280X	A-280X	15-677X	A-677X		
		5-281X	A-281X	SPL170-4X	ASPL170X		
		5-2971X	A-377-1761X				
		5-300X	A-341-1027X				
		5-3147X	A-534G-1014X				
		5-350X	A-445-1006X				
		5-360X	A-360X				
		5-438X	A-438X				
		5-443X	A-437G-1741X				
		5-456X	A-436-1742X				
		5-460X	A-348-1746X				
		5-134X	A-353-1034X				
		5-4X	A-344-1021X				
		5-620X	A-620X				
		5-793X	A-621X				
		5-674X	A-674X				
		5-675	A-675X				
		5-676X	A-676X				
		5-677X	A-677X				

**Diferentes aplicaciones
Una sola calidad**

Autopar[®]

Drive Train

Amplia gama de productos para sistema tren motriz

PARTES DE CARDÁN • EMBRAGUES • PARTES DE DIFERENCIAL
CRUCETAS • PARTES TRANSMISIÓN



CRUCETAS Y PARTES CARDÁN

SOPORTES • CRUCETAS • YUGOS • ABRAZADERAS • NUDOS
Maquinados bajo especificación de E.O. para garantizar
un ensamble correcto.

PARTES DE TRANSMISIÓN

FLECHAS DE MANDO • FLECHAS PRINCIPALES
• TREN DE ENGRANES • ENGRANES
• BALEROS • CONJUNTOS SINCRONIZADORES



EJE DIFERENCIAL

CORONA Y PIÑÓN • SATÉLITES Y PLANETARIOS
SEMIEJES • PORTAENGRANES • BALEROS • KIT DE AJUSTE

Recubrimiento de FOSFATO, para evitar oxidación
y prolongar la vida del producto.

Rediseño en la GEOMETRÍA de los dientes para un mejor
ajuste.



POTENCIA MOTRIZ EN PERFECTA SINCRONÍA

Descubre todos nuestros productos



- **Aplicaciones**
- **Información Técnica**
- **Nuevos Lanzamientos y más...**



Dacomsa S.A. de C.V.

Calz. San Bartolo Naucalpan No. 136 Col. Argentina Poniente, C.P. 11230

Miguel Hidalgo, CDMX, Tel.: (55) 5726 8200

www.dacomsa.com

C-STM LP 01 005 04 0921

INFORMACIÓN IMPORTANTE

La información contenida en este catálogo es la correcta hasta el momento de su impresión y esta sujeta a cambios sin previo aviso; por lo cual no asumimos responsabilidad alguna por errores u omisiones, para actualizaciones consulte nuestra página de internet www.dacomsa.com

